

KWC RONDO Round sink

Modell-Linie: **RONDO | RNDH360**
Washbasins & Washtroughs | Wash basins

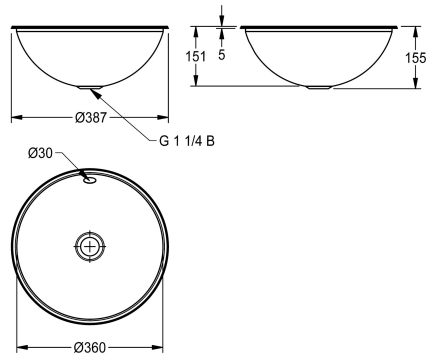

KWC-No.

2000056428

Dimensions 388 x 152 mm (x H) High-polished surface

2000056431

Surface satin-finished

bowl finish

high polished

satin finished

Round inset vanity basin, can be mounted from top or underneath, stainless steel, material thickness 1 mm, bowl diameter 360 mm, with overflow, inclusive G 1 1/4 B overflow kit without waste, stainless steel lugs for underneath mounting are included.

Dimensions 387 x 155 mm (D x H)
Outcut diameter for mounting from top 368 mm
Outcut diameter for mounting from underneath 350 mm
Surface high-polished

Technical Data

bowl position
bowl - bowl height
bowl finish
bowl - depth
bowl shape
bowl - width
colour
material
material code
material thickness
overall depth
overall height
overall width
overflow
rear upstand
siphon included
splash back
surface finish
tap ledge
type of mounting
waste hole position
waste hole projection
waste kit included

center
150 mm
high polished
357 mm
circle
357 mm
No colour
stainless steel
1.4301 Chrome Nickel steel V2A
1 mm
388 mm
150 mm
388 mm
yes
no
no
no
high polished
no
inset mounting
centre
194 mm
no

KWC RONDO Round sink

Modell-Linie: **RONDO | RNDH360**
Washbasins & Washtroughs | Wash basins

waste size

DN 32

Optional Accessories



Waste kit

2000103551
ERNDX003



Waste kit

2000103407
EANMX002



RONDO waste fitting kit

2000101364
E-RNDX-UEL SET



RONDO reduction for outlet valve

2000101362
E-REDUKTION



Outlet valve

2000101361
E-XINH-VALVE-SS



RONDO outlet valve

2000101365
E-XINH VALVE

Spare Parts



Overflow set

2000103422
EANMX010



KWC RONDO
Round sink

Modell-Linie: RONDO | RNDH360
Washbasins & Washtroughs | Wash basins