

KWC RONDO Round sink

Modell-Linie: **RONDO | RNDX381**
Washbasins & Washtroughs | Wash basins

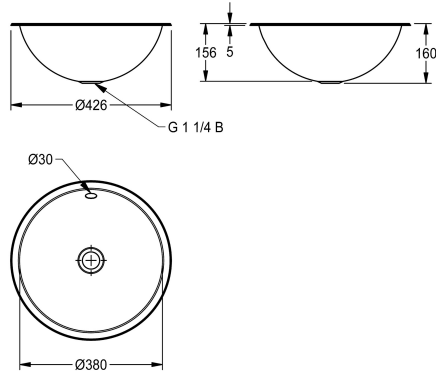

KWC-No.

2000056432

Dimensions 428 x 157 mm (x H) High-polished surface

2000056436

Surface satin-finished

bowl finish

high polished

satin finished

Round inset vanity basin, can be mounted from top or underneath, stainless steel, material thickness 1 mm, bowl diameter 380 mm, with overflow, inclusive G 1 1/4 B overflow kit without waste, stainless steel lugs for underneath mounting are included.

Dimensions 426 x 160 mm (D x H)
Outcut diameter for mounting from top 406 mm
Outcut diameter for mounting from underneath 368 mm
Surface satin finished

Technical Data

bowl position
bowl - bowl height
bowl finish
bowl - depth
bowl shape
bowl - width
colour
material
material code
material thickness
overall depth
overall height
overall width
overflow
rear upstand
siphon included
splash back
surface finish
tap ledge
type of mounting
waste hole position
waste hole projection
waste kit included

center
159 mm
satin finished
380 mm
circle
380 mm
No colour
stainless steel
1.4301 Chrome Nickel steel V2A
1 mm
426 mm
159 mm
426 mm
yes
no
no
no
satin finished
no
inset mounting
centre
214 mm
no

KWC RONDO Round sink

Modell-Linie: **RONDO | RNDX381**
Washbasins & Washtroughs | Wash basins

waste size

DN 32

Optional Accessories



Waste kit

2000103551
ERNDX003



Waste kit

2000103407
EANMX002



RONDO waste fitting kit

2000101364
E-RNDX-UEL SET



RONDO reduction for outlet valve

2000101362
E-REDUKTION



Outlet valve

2000101361
E-XINH-VALVE-SS



RONDO outlet valve

2000101365
E-XINH VALVE

Spare Parts



Overflow set

2000103422
EANMX010



KWC RONDO
Round sink

Modell-Linie: RONDO | RNDX381
Washbasins & Washtroughs | Wash basins