

KWC MAXIMA Commercial sink

Modell-Linie: MAXIMA | MAXS 100-60
Catering sinks | Catering sinks

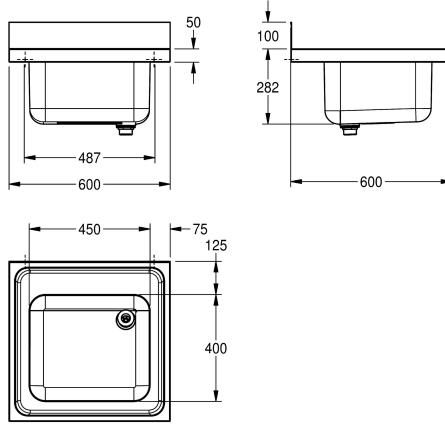

KWC-No.

2000057616

Dimensions 600 x 382 x 600 mm (W x H x D) Washbasin
dimensions 450 x 250 x 400 mm (W x H x D)

Commercial sink for inset or wall mounting, stainless steel, surface satin finished, material thickness 1 mm, deep drawn seamless welded bowl, without overflow and 80 mm tap ledge, 1 1/2" waste with two part overflow tube consisting of perforated stainless steel

tube and plastic tube, 100 mm rear upstand, wall mounting brackets optional, drilling holes for wall mounting prelasered.

Dimensions 600 x 382 x 600 mm (W x H x D)

Technical Data

bowl - bowl height	250 mm
bowl finish	satin finished
bowl - depth	400 mm
bowl - width	450 mm
drainer or storage	no
material	stainless steel
material code	1.4301 Chrome Nickel steel V2A
material thickness	1 mm
noise prevention	yes
overall depth	600 mm
overall height	382 mm
overall width	600 mm
rear upstand	yes
surface finish	satin finished
tap ledge	yes
type of mounting	mounted on product
waste hole position	right back corner
waste hole projection	221 mm
waste kit included	yes
waste size	DN 40



Optional Accessories

KWC MAXIMA Commercial sink

Modell-Linie: MAXIMA | MAXS 100-60
Catering sinks | Catering sinks



MAXIMA Bracket

2000057092
MAXB600

MAXIMA Frame for Maxima

2000057122
MAXF60-60

MAXIMA Shelf for Maxima

2000057763
MAXT60-60
