

KWC MAXIMA Commercial sink

Modell-Linie: MAXIMA | MAXS217-160
Catering sinks | Catering sinks

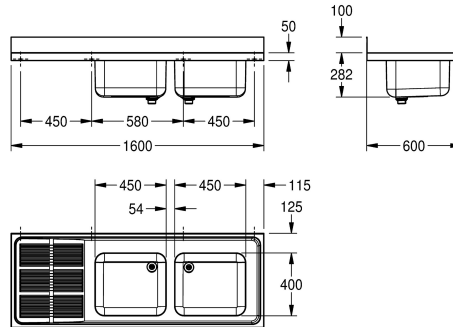

KWC-No.

2000057704
Drip section right

2000057708
Drip section left

drainer position

right

left

Commercial sink for inset or wall mounting, stainless steel, surface satin finished, material thickness 1 mm, two deep drawn seamless welded bowls, without overflow and 80 mm tap ledge, bowls left or right, 1 1/2" waste with two part overflow tube consisting of perforated stainless steel tube and plastic tube, drain board with

rifle and slanted to bowl, drain board with reinforced stainless steel bracket, 100 mm rear upstand, wall mounting brackets optional, drilling holes for wall mounting prelasered.

Drain board left

Technical Data

bowl - bowl height

250 mm

bowl finish

satin finished

bowl - depth

400 mm

bowl - width

450 mm

drainer position

left

drainer or storage

drainer

drainer / storage board quanti

1-

material

stainless steel

material code

1.4301 Chrome Nickel steel V2A

material thickness

1 mm

noise prevention

yes

overall depth

600 mm

overall height

382 mm

overall width

1,600 mm

rear upstand

yes

surface finish

satin finished

tap ledge

yes

type of mounting

mounted on product

waste hole position

left back corner

waste hole projection

221 mm

waste kit included

yes

waste size

DN 40

Optional Accessories

KWC

MAXIMA Commercial sink

Modell-Linie: MAXIMA | MAXS217-160
Catering sinks | Catering sinks



MAXIMA Bracket

2000057092
MAXB600



MAXIMA Frame for Maxima

2000057112
MAXF160-60



MAXIMA Shelf for Maxima

2000057758
MAXT160-60
