

KWC SIRIUS

Workroom sink with stand pipe valve

Modell-Linie: SIRIUS | SIRX753

Utility sinks | Multi purpose sink

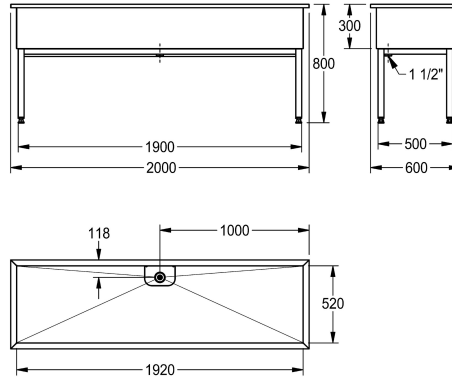

KWC-No.

2000100068

Dimensions 1000 x 800 x 600 mm (W x H x D) Washbasin
dimensions 920 x 300 x 520 mm (W x H x D)

2000100357

Dimensions 1500 x 800 x 600 mm (W x H x D) Washbasin
dimensions 1420 x 300 x 520 mm (W x H x D)

2000100359

Dimensions 2000 x 800 x 600 mm (W x H x D) Washbasin
dimensions 1920 x 300 x 520 mm (W x H x D)

overall width

1,000 mm

1,500 mm

2,000 mm

Workroom sink, stainless steel, surface satin finished, material thickness 1.2 mm, 38 mm waste fitting with 1 1/2" standing plug/overflow tube and strainer, with stainless steel square tube

base frame, height adjustable.

Dimensions 2000 x 800/300 x 600 mm (W x H x D)

Technical Data

bowl position
bowl construction
bowl - bowl height
bowl finish
bowl - depth
bowl - width
drainer or storage
grid
material
material code
material thickness
number of waste holes
outlet size
overall depth
overall height
overall width
overflow
rear upstand
wash riffle
splash back
sump

Center
square corner
300 mm
satin finished
520 mm
1,920 mm
no
no
stainless steel
1.4301 Chrome Nickel steel V2A
1.2 mm
1
G 1 1/2 B
600 mm
800 mm
2,000 mm
stand pipe overflow
no
no
no
no

KWC SIRIUS

Workroom sink with stand pipe valve

Modell-Linie: SIRIUS | SIRX753

Utility sinks | Multi purpose sink

sump basket	no
surface finish	satin finished
tap ledge	no
type of mounting	no mounting
type of utility sink	cleaner sink
type of waste kit	standpipe strainer
waste hole position	centre back
waste hole projection	118 mm
waste kit included	yes
waste size	DN 40

Spare Parts



Stainless steel care set

2000109019
ZWSPL0024

Cleaning product CHROMOL

2000105091
ZWSPL0023