

KWC SIRIUS Workroom sink

Modell-Linie: SIRIUS | SIRX756
Utility sinks | Multi purpose sink

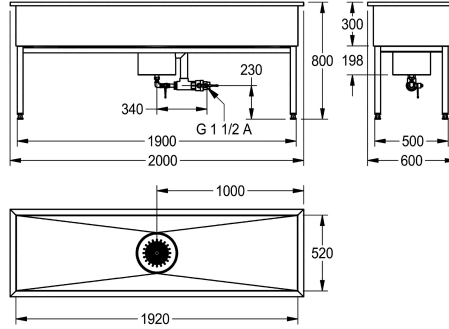

KWC-No.

2000100360

Dimensions 1000 x 800 x 600 mm (W x H x D) Washbasin
dimensions 920 x 300 x 520 mm (W x H x D)

2000100361

Dimensions 1500 x 800 x 600 mm (W x H x D) Washbasin
dimensions 1420 x 300 x 520 mm (W x H x D)

2000100362

Dimensions 2000 x 800 x 600 mm (W x H x D) Washbasin
dimensions 1920 x 300 x 520 mm (W x H x D)

overall width

1,000 mm

1,500 mm

2,000 mm

Workroom sink, stainless steel, surface satin finished, material thickness 1.2 mm, base drainage hole with waste body and sludge trap bucket in stainless steel welded on, overflow DN 40 and outlet spigot DN 15, waste set with ball stop valve DN 40 and DN 15,

with stainless steel square tube base frame, height adjustable.

Dimensions 2000 x 800 x 600 mm (W x H x D)
Bowl Dimensions 1920 x 300 x 520 mm (W x H x D)

Technical Data

bowl position

Center

bowl construction

square corner

bowl - bowl height

300 mm

bowl finish

satin finished

bowl - depth

520 mm

bowl - width

1,920 mm

drainer or storage

no

grid

no

material

stainless steel

material code

1.4301 Chrome Nickel steel V2A

material thickness

1.2 mm

number of waste holes

1

outlet size

G 1 1/2

overall depth

600 mm

overall height

800 mm

overall width

2,000 mm

overflow

yes

rear upstand

no

wash riffle

no

splash back

no

sump

yes

KWC SIRIUS Workroom sink

Modell-Linie: SIRIUS | SIRX756
Utility sinks | Multi purpose sink

sump basket	included
sump depth	198 mm
sump diameter	254 mm
surface finish	satin finished
tap ledge	no
type of mounting	no mounting
type of utility sink	cleaner sink
type of waste kit	flat perforated waste
upper edge of basin height	800 mm
waste hole position	centre
waste hole projection	300 mm
waste kit included	yes
waste size	DN 40

Spare Parts



Stainless steel care set

2000109019
ZWSP0024

Cleaning product CHROMOL

2000105091
ZWSP0023