

KWC ANIMA Single washbasin

Modell-Linie: ANIMA | WT500A-M
Washbasins & Washtroughs | Wash basins

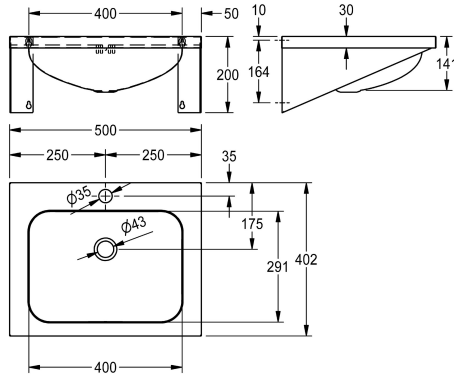

KWC-No.

2000103764

With 35 mm diameter tap hole, centered

number of tap holes

1

Single wash basin for wall mounting, stainless steel, surface satin finished, material thickness 1 mm, seamless welded bowl with diameter 500 x 400 x 200 mm, rectangular shape, 70 mm tap ledge, with overflow, 1 1/4" plug waste, drainage rewards centric,

prewelded mounting brackets, includes screws and dowels.

With taphole
Dimensions 500 x 200 x 402 mm (W x H x D)

Technical Data

type of basin
bowl position
bowl - bowl height
bowl finish
bowl - depth
bowl shape
bowl - width
colour
material
material code
material thickness
overall depth
overall height
overall width
overflow
overflow position
rear upstand
siphon diameter
siphon included
splash back
surface finish
number of tap holes
tap hole diameter
tap hole position
tap ledge
type of mounting

Wash basin
center
141 mm
satin finished
291 mm
rectangle
400 mm
No colour
stainless steel
1.4301 Chrome Nickel steel V2A
1 mm
402 mm
200 mm
500 mm
yes
back
no
DN 32
no
optional
satin finished
1
35 mm
middle
yes
wall mounting



KWC ANIMA Single washbasin

Modell-Linie: ANIMA | WT500A-M
Washbasins & Washtroughs | Wash basins

type of waste kit	plug waste
waste hole position	centre back
waste hole projection	175 mm
waste kit included	yes
waste size	DN 32
waste sleeve included	no

Optional Accessories



ANIMA splash back

2000100066
SB500

Spare Parts

Fixing set

2000103414
ECMPX023