

## KWC

### F3E-Therm electronic thermostatic wall-mounted mixer

Modell-Linie: F3E | F3ET1003  
Taps | Electronic taps

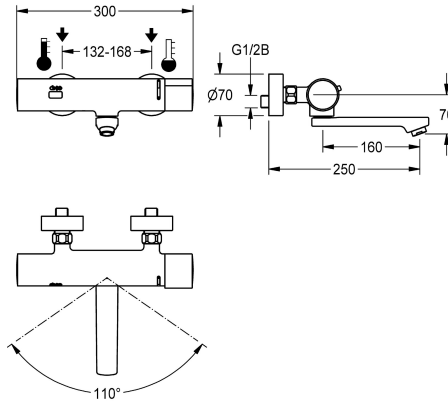

#### KWC-No.

**2030032506**

**2030032507**

Projection 130 mm

**2030026612**

Projection 250 mm

#### spout projection

190 mm

130 mm

250 mm

F3E-Therm thermostatic mixer DN 15 for wall mounting with lockable swivelling spout, for sanitary facilities. Opto-electronically controlled, triggered via hand movement. Thermostat with metal handle with adjustable and turn-proof temperature stop. With the option of manual thermal disinfection. For connection to hot and cold water. Control electronics, solenoid valve cartridge, 6 V lithium battery (CR-P2) and sensor in all-metal housing, high-polished

chromium-plated brass. Laminar jet controller with integrated flow regulator 6.0 l/min. With adjustable connections with backflow preventer, strainers and screw rosettes. Projection 250 mm. Activated water hygiene flushing 24 hours after last activation, safety switch-off with continuous reflection and saving of statistical data. With option for parameterization and communication via optional, bidirectional remote control.

#### Technical Data

with backflow preventer

yes

calculation flow rate cold wat

0.07 l/s

calculation flow rate hot water

0.07 l/s

compatible A3000 open

no

default automatic hygiene flush

24h after the last activity

default flow time

10 Seconds

depressurised

no

with filter

yes

adjustable flow time

yes

functional principle

electronic self-closing

hygiene flushing

yes

diameter nominal

DN 15

inlet size

G 1/2 B

Locking mechanism

Top section, non-ceramic

material fitting

brass

maximum flow time

255 Seconds

minimum flow pressure

1 bar

minimum flow time

1 Seconds

type of mixing

with thermostat

number of batteries

1

Parameterization

remote control

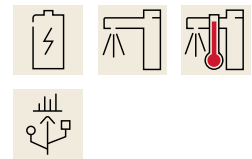

## KWC

### F3E-Therm electronic thermostatic wall-mounted mixer

Modell-Linie: F3E | F3ET1003

Taps | Electronic taps

Pop-up waste set	no
power supply connection	Battery 6 V
power consumption	1.5 Voltampere
Type of power supply	Battery
protective system IP	IP59K
with rosettes/cover plate	yes
protective shutdown	yes
sound insulation	no
Spout	rotating, bottom
spout projection	250 mm
surface finish fitting	chromed
surface treatment fitting	polished
temperature limit	yes
thermal disinfection	manual thermal disinfection
with transformer/power supply	no
type of batteries	CR-P2 Lithium battery 6V
type of mounting	wall mounting
type of operation	sensor operation
type of sensor	opto-electronic sensor
type of tap	bib tap
volume flow rate at 3 bar	0.1 l/s
water connection	S-connections
Accent colour	none
Basic colour	chrome-look (glossy)

### Optional Accessories



**Bidirectional remote control for electronic fittings F3 and F5**

**2030036654**  
ACEX9005



**2-button remote control for fittings F3 and F5**

**2030036849**  
ACEX9004



**Theft-proof housing for aerator**

**2000104778**  
ZTAPS0005



**Screw connection**

**2030041416**  
ACXX9001

### Spare Parts

## KWC

F3E-Therm electronic thermostatic wall-mounted mixer

Modell-Linie: F3E | F3ET1003  
Taps | Electronic taps

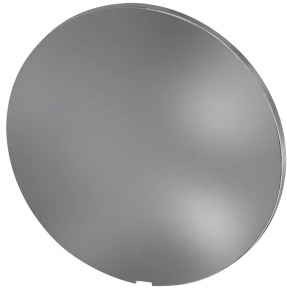

Cover

**2030003258**  
EAQLT0002



Lithium battery 6 V

**2000104846**  
EPTR0008



Solenoid valve cartridge

**2030045522**  
ACXX9002



F5 Foil

**2030053034**  
ASET2010

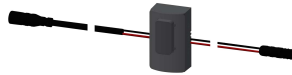

Sensor, ID 02/00001

**2030041449**  
ASET1001



Laminar jet regulator

**2030012352**  
ETAPS0037

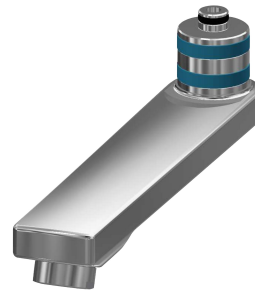

Swivel spout, 160 mm

**2030032815**  
ASXX1002



Mounting set

**2030003401**  
EAQLT0009

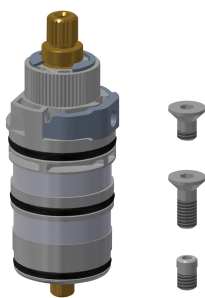

Thermocouple

**2030003300**  
EAQLT0004

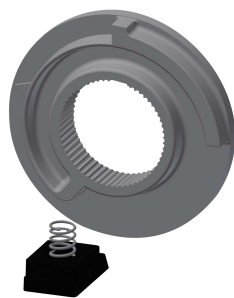

Temperature stop

**2030003296**  
EAQLT0003



Hexagonal socket wrench

**2030047722**  
ACEX9011