

KWC F5E-Mix Electronic pillar mixer with battery operation

Modell-Linie: F5E | F5EM1001
Taps | Electronic taps

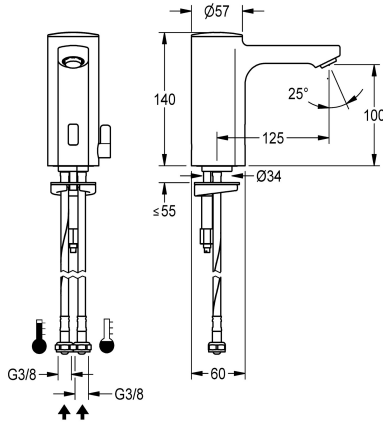

KWC-No.

2030027923

2030039427

with flow regulator 3.0 l/min

volume flow rate at 3 bar

0.08 l/s

0.05 l/s

F5E-Mix pillar mixer DN 15 for sanitary facilities, opto-electronically controlled. For connection to hot and cold water via hoses with integrated backflow preventer and strainers. Control electronics, solenoid valve cartridge, 6 V lithium battery (CR-P2) and sensor in all-metal housing, high-polished chromium-plated brass. Temperature lever with adjustable, turn-proof temperature stop as

well as conversion set for concealed mixing device. Anti-theft aerator, design SLIM, with integrated flow regulator 5.0 l/min. Activated water hygiene flushing 24 hours after last activation, safety switch-off with continuous reflection and saving of statistical data. With option for parameterization and communication via optional, bidirectional remote control.

Technical Data

with backflow preventer

calculation flow rate cold wat

calculation flow rate hot water

compatible A3000 open

default automatic hygiene flus

depressurised

with filter

functional principle

hygiene flushing

diameter nominal

inlet size

Locking mechanism

material fitting

minimum flow pressure

type of mixing

number of batteries

Parameterization

Pop-up waste set

power supply connection

Type of power supply

protective system IP

with rosettes/cover plate

protective shutdown

yes

0.07 l/s

0.07 l/s

no

24h after the last activity

no

yes

electronic self-closing

yes

DN 15

G 3/8

Top section, non-ceramic

brass-look

1 bar

yes

1

remote control

no

Battery 6 V

Battery

IP59K

no

yes



KWC F5E-Mix

Electronic pillar mixer with battery operation

Modell-Linie: F5E | F5EM1001

Taps | Electronic taps

sound insulation	no
Spout	fixed
spout projection	125 mm
surface finish fitting	chromed
surface treatment fitting	polished
temperature limit	yes
thermal disinfection	no
with transformer/power supply	no
type of batteries	CR-P2 Lithium battery 6V
type of mounting	tap hole
type of operation	sensor operation
type of sensor	opto-electronic sensor
type of tap	pillar tap
volume flow rate at 3 bar	0.08 l/s
water connection	hose (gland nut)
Accent colour	none
Basic colour	chrome-look (glossy)

Optional Accessories



Bidirectional remote control for electronic fittings F3 and F5

2030036654
ACEX9005



2-button remote control for fittings F3 and F5

2030036849
ACEX9004



Socket

2030040334
ACEX1001

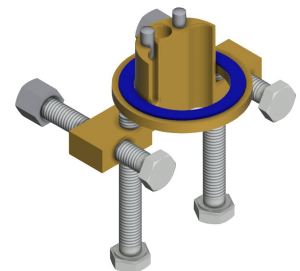

Anti-twist protection for F5S

2030035383
ACXX1001



PURETHERM under-table thermostat

2030012758
PURE0031



5.0 l/min aerator, angle-adjustable

2030041326
ACXX1002



3.0 l/min. aerator

2030041424
ASXX1008

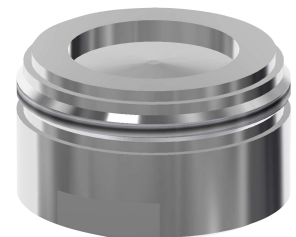

Aerator 1.8 l/min

2030041442
ACXX1005

KWC F5E-Mix Electronic pillar mixer with battery operation

Modell-Linie: F5E | F5EM1001
Taps | Electronic taps

Spare Parts

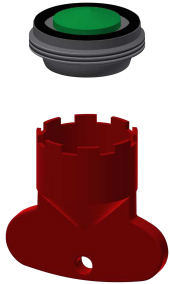

Aerator 5.0 l/min

2030041011
ASXX1004



Mounting key

2030041329
ACXX1003



Cap

2030041558
ASEX1007



Battery compartment

3600002063
ACEX9023



Lithium battery 6 V

2000104846
EPRT0008

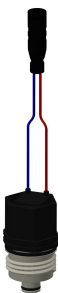

Solenoid valve cartridge

2030045522
ACXX9002

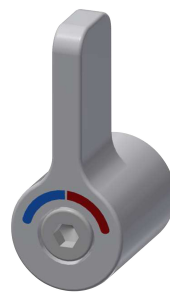

Temperature selection lever

2030041431
ASEM1001



Hose

2030041320
ASXM1001

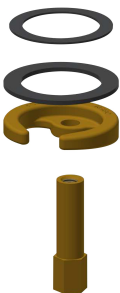

Quick-action fastener

2030043596
ASEX1013



Water way

2030041949
ASEX1008

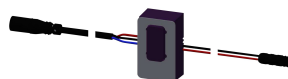

Sensor, ID 01/00004

2030041458
ASEX1005

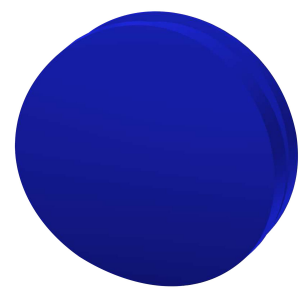

Plug blue

2030041952
ASEX1010



KWC F5E-Mix

Electronic pillar mixer with battery operation

Modell-Linie: F5E | F5EM1001

Taps | Electronic taps

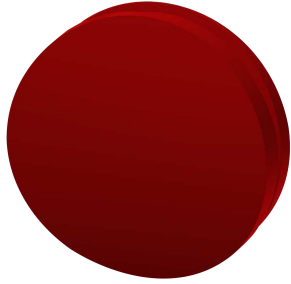

Plug red

2030041951

ASEX1009
