

KWC F5E-Mix

Electronic pillar mixer with battery operation for hot water heaters

Modell-Linie: F5E | F5EM1005

Taps | Electronic taps

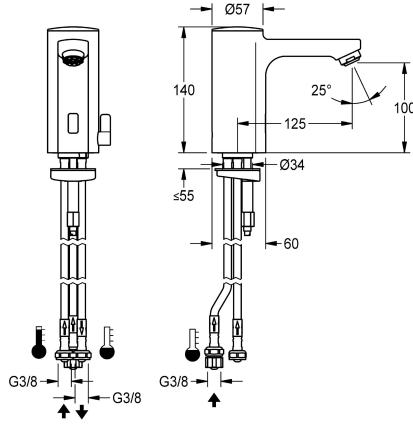

KWC-No.

2030031350

F5E-Mix pillar mixer DN 15 for sanitary facilities, opto-electronically controlled. For connection via hoses to open low-level domestic hot water heaters. Control electronics, solenoid valve cartridge, 6 V lithium battery (CR-P2) and sensor in all-metal housing, high-polished chromium-plated brass. Temperature lever with adjustable, turn-proof temperature stop as well as conversion set

for concealed mixing device. With jet controller. Activated water hygiene flushing 24 hours after last activation, safety switch-off with continuous reflection and saving of statistical data. With option for parameterization and communication via optional, bidirectional remote control.

Technical Data

with backflow preventer	yes
calculation flow rate cold wat	0.08 l/s
compatible A3000 open	no
default automatic hygiene flus	24h after the last activity
depressurised	yes
with filter	yes
functional principle	electronic self-closing
hygiene flushing	yes
diameter nominal	DN 15
inlet size	G 3/8
Locking mechanism	Top section, non-ceramic
material fitting	brass-look
minimum flow pressure	1 bar
type of mixing	yes
number of batteries	1
Parameterization	remote control
Pop-up waste set	no
power supply connection	Battery 6 V
power consumption	1.5 Voltampere
Type of power supply	Battery
protective system IP	IP59K
with rosettes/cover plate	no
protective shutdown	yes
sound insulation	no
Spout	fixed



KWC F5E-Mix

Electronic pillar mixer with battery operation for hot water heaters

Modell-Linie: F5E | F5EM1005

Taps | Electronic taps

spout projection	125 mm
surface finish fitting	chromed
surface treatment fitting	polished
temperature limit	yes
thermal disinfection	no
with transformer/power supply	no
type of batteries	CR-P2 Lithium battery 6V
type of mounting	tap hole
type of operation	sensor operation
type of sensor	opto-electronic sensor
type of tap	pillar tap
volume flow rate at 3 bar	0.08 l/s
water connection	hose (gland nut)
Accent colour	none
Basic colour	chrome-look (glossy)

Optional Accessories



Bidirectional remote control for electronic fittings F3 and F5

2030036654
ACEX9005



2-button remote control for fittings F3 and F5

2030036849
ACEX9004



Unpressurised small storage tank

2000109145
ACXM1001

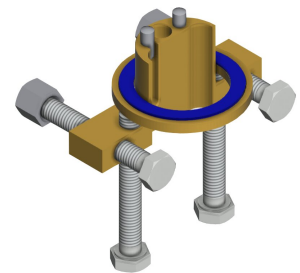

Anti-twist protection for F5S

2030035383
ACXX1001

Spare Parts



Cap

2030041558

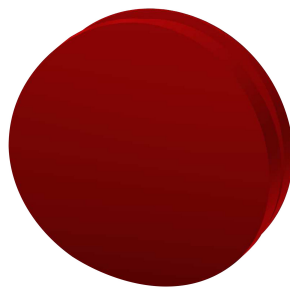

Plug red

2030041951

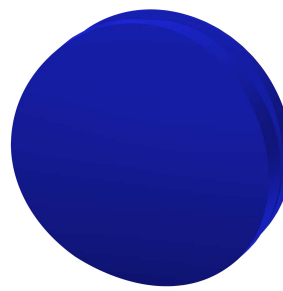

Plug blue

2030041952



Battery compartment

3600002063

KWC F5E-Mix

Electronic pillar mixer with battery operation for hot water heaters

Modell-Linie: F5E | F5EM1005

Taps | Electronic taps

ASEX1007



Lithium battery 6 V

2000104846
EPRTR0008

ASEX1009

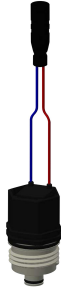

Solenoid valve cartridge

2030045522
ACXX9002

ASEX1010



Temperature selection lever

2030041431
ASEM1001

ACEX9023



Hose

2030041311
ASXX1005



Hose

2030041313
ASXX1006

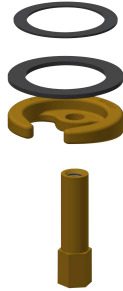

Quick-action fastener

2030043596
ASEX1013



Water way

2030041949
ASEX1008

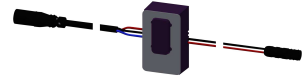

Sensor, ID 01/00004

2030041458
ASEX1005