

## KWC F5S-Therm Self-closing thermostatic wall-mounted mixer

Modell-Linie: F5S | F5ST1002  
Taps | Self closing taps

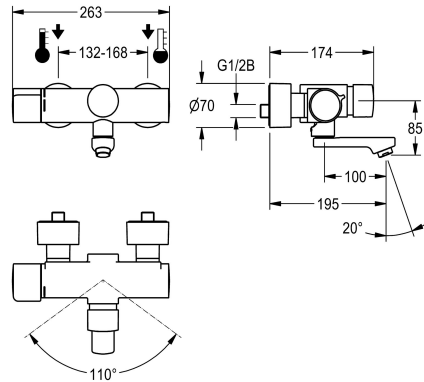

### KWC-No.

**2030032963**

Projection 195 mm

**2030032959**

Projection 135 mm

**2030032967**

Projection 255 mm

### spout projection

195 mm

135 mm

255 mm

F5S-Therm self-closing thermostat wall mixer DN 15 for wall mounting with lockable swivelling spout, for sanitary facilities. Hydraulically controlled, connects to hot water and cold water. With a mechanism for an optional water hygiene unit for automatic hygiene flushing and storage of statistical data. FRAMIC self-closing cartridge, hydraulically controlled, low-maintenance and stagnation-free, with ceramic disc technology, self-closing, flow pressure-independent due to medium-separated design. Stepless

adjustment of flow duration. Thermostat with metal handle with adjustable and turn-proof temperature stop, with option for performance of manual thermal disinfection. Scald-protected, safe-touch housing, all-metal construction, high-polished chromium-plated brass. Laminar jet controller with integrated flow regulator 6.0 l/min. With adjustable and lockable connections with backflow preventer and strainers, completely covered with depth-adjustable screw rosettes. Projection 195 mm.

### Technical Data

with backflow preventer

calculation flow rate cold wat

calculation flow rate hot wate

compatible A3000 open

depressurised

with filter

adjustable flow time

functional principle

hygiene flushing

diameter nominal

inlet size

Locking mechanism

material fitting

maximum flow time

minimum flow pressure

minimum flow time

type of mixing

Pop-up waste set

with rosettes/cover plate

protective shutdown

yes

0.07 l/s

0.07 l/s

no

no

yes

yes

hydraulic self-closing

prepared

DN 15

G 1/2 B

Top section, ceramic

brass-look

35 Seconds

1 bar

5 Seconds

with thermostat

no

yes

no



## KWC F5S-Therm Self-closing thermostatic wall-mounted mixer

**Modell-Linie: F5S | F5ST1002**  
Taps | Self closing taps

sound insulation	no
Spout	rotating, bottom
spout projection	195 mm
surface finish fitting	chromed
surface treatment fitting	polished
temperature limit	yes
thermal disinfection	manual
type of mounting	wall mounting
type of operation	manual operation
type of tap	bib tap
volume flow rate at 3 bar	0.1 l/s
water connection	S-connections
Accent colour	none
Basic colour	chrome-look (glossy)

### Optional Accessories

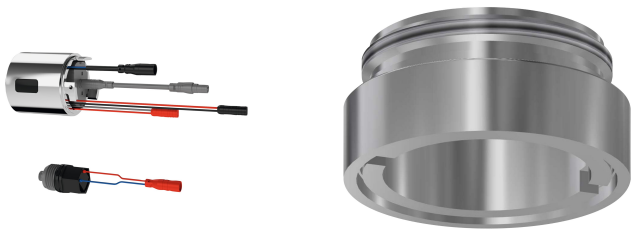

#### Hygiene unit for F5S-Therm

**2030041162**  
ACST9001

#### Theft-proof housing for aerator

**2000104778**  
ZTAPS0005

### Spare Parts



#### Cover

**2030003258**  
EAQLT0002



#### Temperature handle

**2030050541**  
ASXT9004

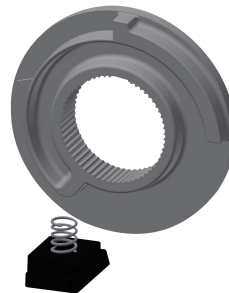

#### Temperature stop

**2030003296**  
EAQLT0003

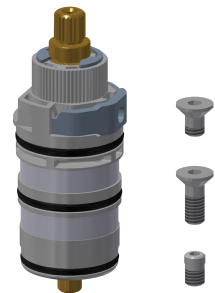

#### Thermocouple

**2030003300**  
EAQLT0004

## KWC F5S-Therm Self-closing thermostatic wall-mounted mixer

Modell-Linie: F5S | F5ST1002  
Taps | Self closing taps



**Screw rosette**

**2030046777**  
ASXX9003



**Mounting set**

**2030003401**  
EAQLT0009



**Push cap**

**2030050542**  
ASST9001



**Safety ring**

**2030048357**  
ASSX9003



**FRAMIC Self-closing cartridge**

**2030046145**  
ASSX9001



**Laminar jet regulator**

**2030012352**  
ETAPS0037

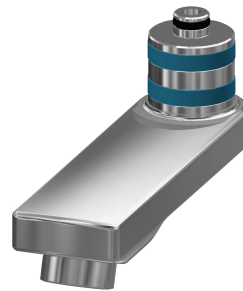

**Swivel spout, 100 mm**

**2030032671**  
ASXX1001