

Installation and operating instructions

Reader

Best.-Nr.: 2030036654
ACEX9005

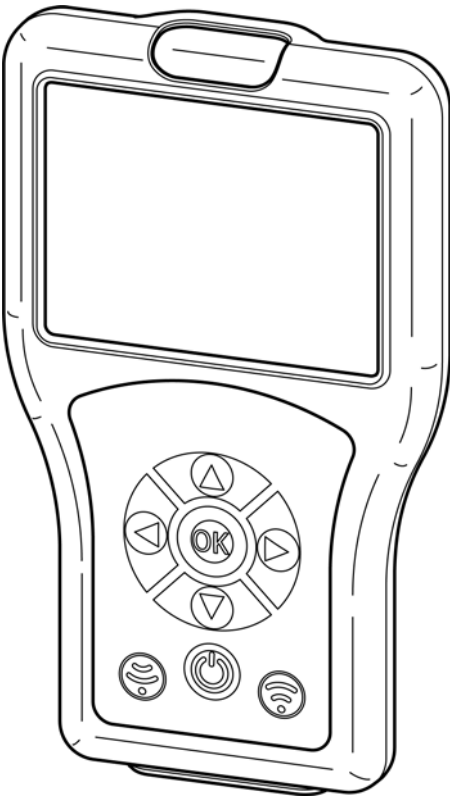

- DE
- EN**
- FR
- ES
- IT
- NL
- PL
- SV
- CS
- FI
- RU

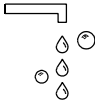
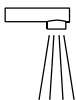

WC

Table of contents

1. Abbreviations and units	4
2. Key	4
3. Warranty	4
4. Important notes	4
Description of product	
5. Scope of delivery	5
6. Dimensions	5
7. Construction	6
8. Operation	7
9. Menu Structure	8
System settings	
10. Charging the Reader	9
11. Date/Time	10
12. System Setting	11
13. USB Mass Storage Mode	12
14. FirmwareUpdate	13
15. Settings Readout	14
16. Settings Memory	15
17. Displaying Stored Settings	15
18. Sending Settings	16
19. Deleting Stored Settings	17
Basic settings	
20. Setting Flow Time	18
21. Setting Run On Time	19
22. Setting Range	20
23. Setting Mode of Operation	21
24. Activating Power Function	22
25. Activating Power On Rinse	23
26. Activating TouchCODE	24
27. Setting Cleaning Time	25
28. Switching on Cleaning Time	26
29. Setting Safety Shutdown	27
30. Switching off the tap	27
Continuous operation	
31. Switching on the Basin Filling function	28
32. Setting Basin Filling/Continuous Operation	29
33. Starting Basin Filling/Continuous Operation	30

Body Approach

- 34. Switching on DetectionFeedback 31
- 35. Switching on Body Approach 32

Hygiene Purge

- 36. Switching Hygiene Purge on/off 33
- 37. Setting Hygiene Interval 34
- 38. Setting Hygiene Flow Time 35
- 39. Starting Hygiene Purge 36

Thermal Disinfection

- 40. Requests for thermal disinfection 37
- 41. Setting TD Delay Time 38
- 42. Setting TD Impact Time 39
- 43. Setting TD Cooling Time 40
- 44. Setting TD Safety Period 41
- 45. Setting TD Water Saving Function 42
- 46. Start Thermal Disinfection 43





Statistics

- 47. Activating Statistics 45
- 48. Statistics Readout and Display 46
- 49. Display statistics 47
- 50. Storing Statistics 48

1. Abbreviations and units

STB	Standby
PC	Personal Computer
Bist	Bistable
Mono	Monostable
m	Minute
h	Hour
s	Second

2. Key

-  **Warning!**
Failure to observe can result in bodily injury or even death.
-  **Caution!**
Failure to observe can result in material damage.
-  **Important!**
Failure to observe can cause the product to malfunction.
-  Useful information for optimum handling of the product.

3. Warranty

Liability is accepted in accordance with the General Terms and Conditions of Business and Supply.

-  **Caution!**
The statistical data is provided to show trends in user behaviour and frequency of use.
The hygiene purge data is provided to assist the user in complying with the incumbent operator obligations. However, it cannot replace them. We strongly recommend that the operator checks the hygiene purge function at regular intervals.

4. Important notes

-  **Warning!**
Infrared radiation
Do not look directly into the sensor window.

5. Scope of delivery

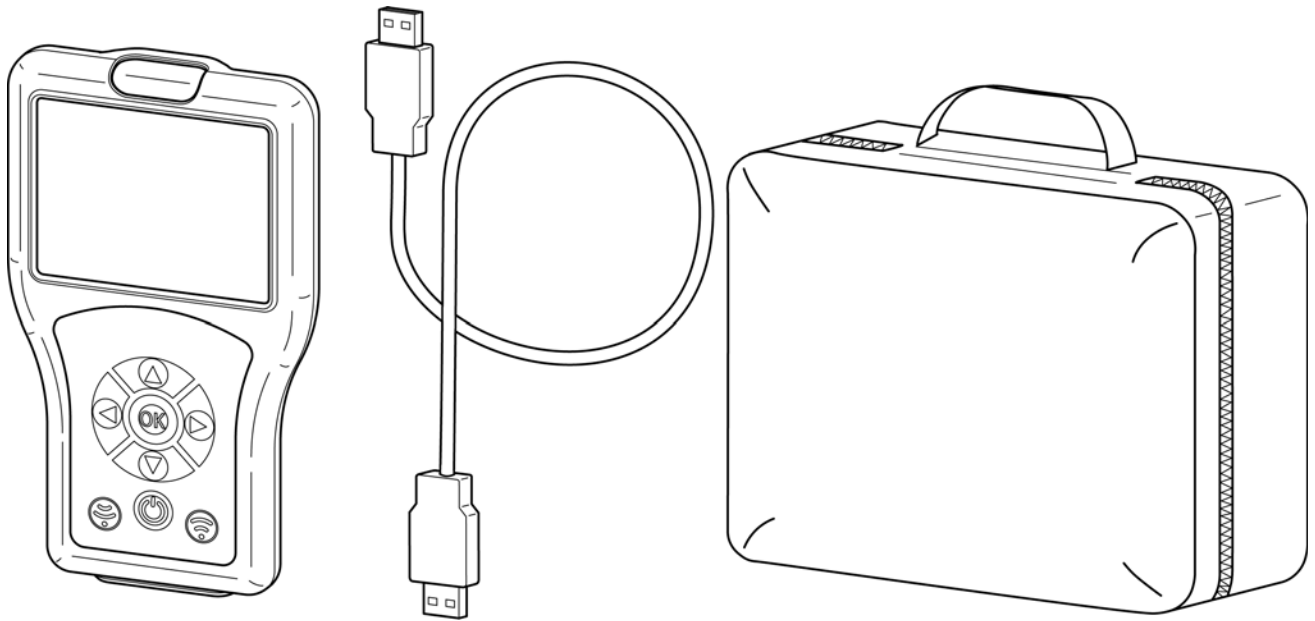

6. Dimensions

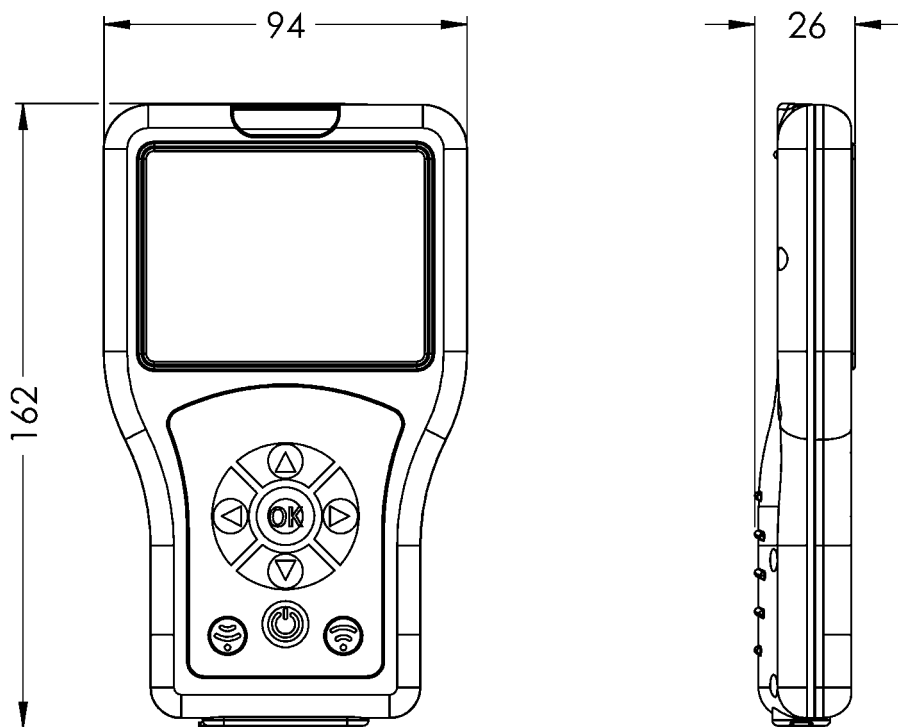

7. Construction

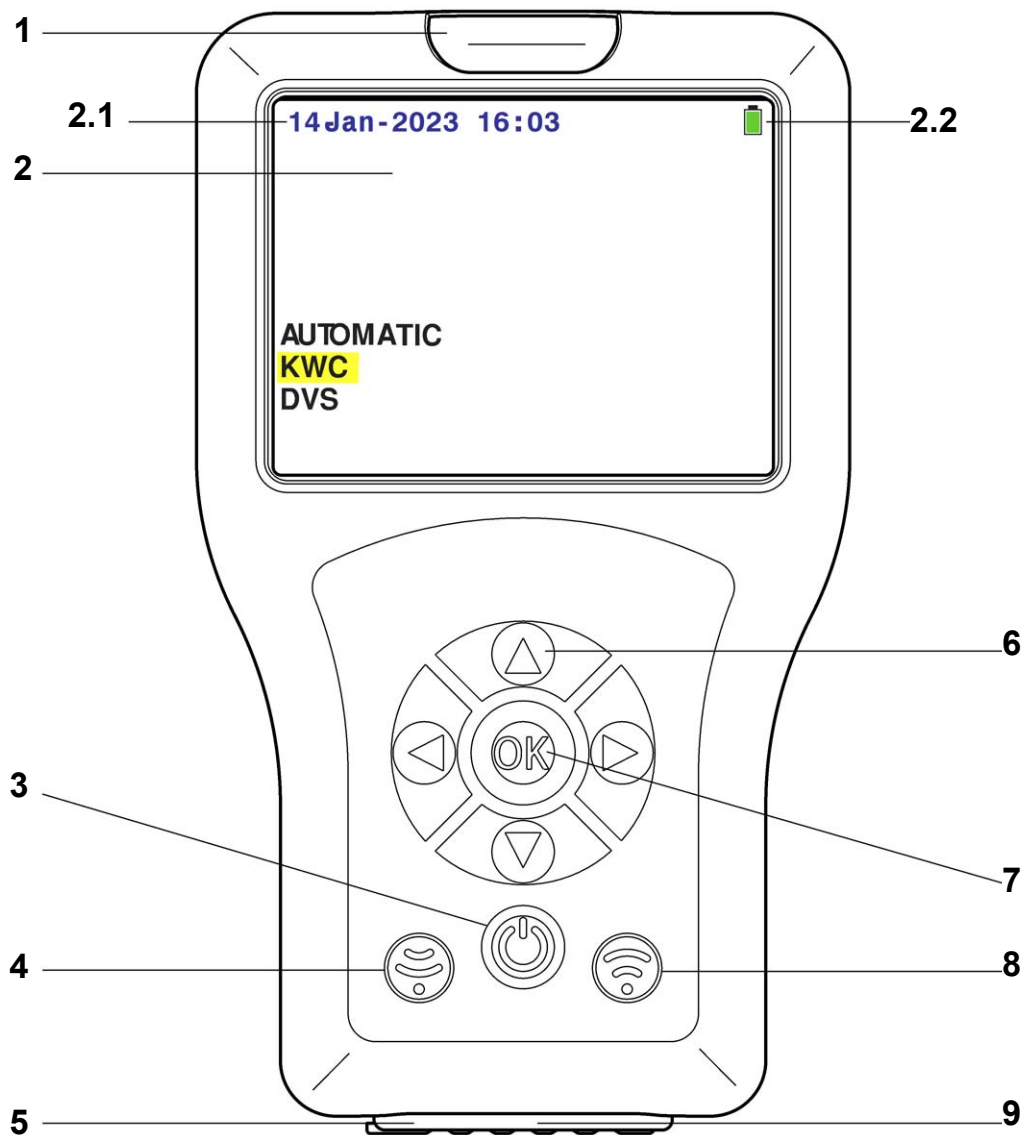

No.	Designation
1	Opto-electronic interface (infrared)
2	Display
2.1	Date/Time
2.2	Battery status
3	On/Off button (Standby)
4	Receive button
5	On/Off switch
6	Navigation buttons
7	OK button
8	Send button
9	USB Interface

8. Operation

The sensor functions differ depending on their application cases. There are different executable sensor functions for each tap. The Reader automatically identifies the right tap family. Operation is described on the basis of a Standard Tap in these instructions for ease of understanding. The menu navigation is identical for each type of Aquarotter tap. Only the scope of the lowest menu levels differs.

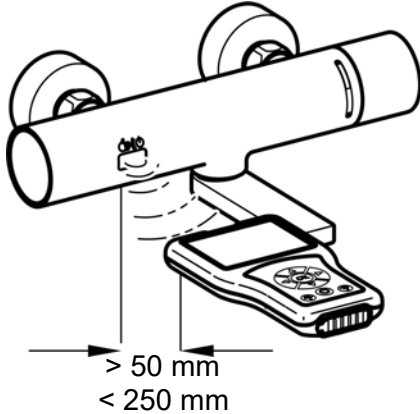

The Reader sends signals via the opto-electronic interface. The sensor of the tap and the opto-electronic interface of the Reader require visual contact with a minimum distance of at least 50 mm and a maximum distance of 250 mm to make settings.

Important!

The sensor must be activated before using the Reader (move your hand towards the sensor).

The Reader is controlled via the following buttons:

- The “OK” button opens a menu item and confirms changes, whereby the menu item is exited at the same time.
- The “▲▼” buttons are used to navigate through the menu items.
- The “◀” button is used to navigate to the previous menu level.
- The “◀▶” buttons are used for navigation or setting parameters.
- The “📶” button is used to send settings/parameters to the tap.
- The “📶” button is used to receive pre-set parameters/statistical data from the tap.
- The “🔌” button switches the Reader to Standby Mode or from Standby Mode.

 A selected line or field is highlighted in yellow.

If an action has been successfully sent to the tap, it is displayed with the following icon:



If an action has not been successfully sent, it is displayed with the following icon:



9. Menu Structure

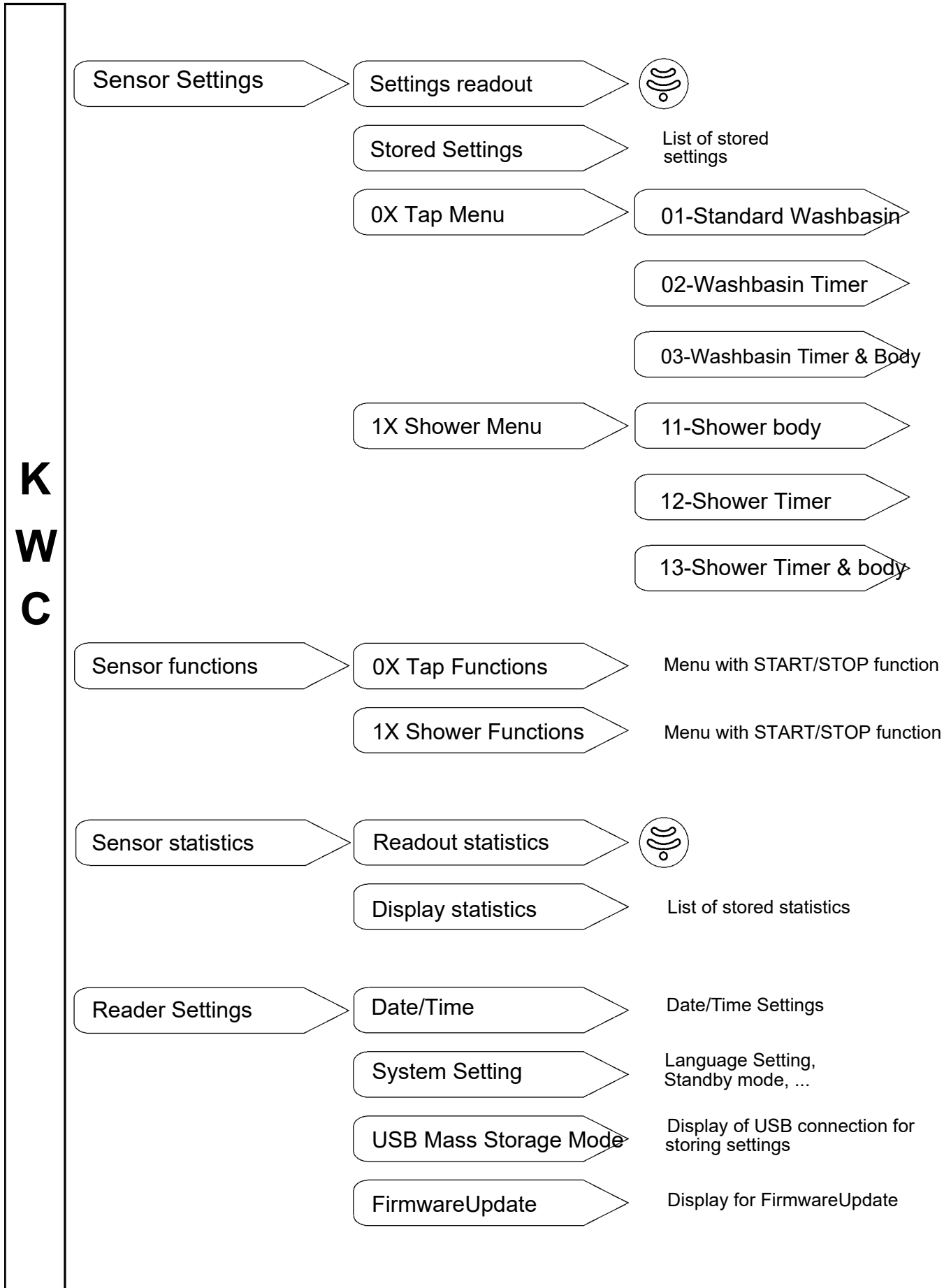

10. Charging the Reader



Caution!

Charge the Reader with a max. 0.5 A (5 V DC).

Charging with the Reader switched on:

10.1 Connect the Reader to a PC.

- The following icon appears in the top right-hand corner of the Reader display:



Charging with the Reader switched off:

10.2 Connect the Reader to a PC.

- The following display appears on the Reader:



Charging Battery
Voltage: 5.4V

11. Date/Time

The date and time are shown in the top left-hand corner of the display in all menu levels.

Select the following menu items to go to the destination display:

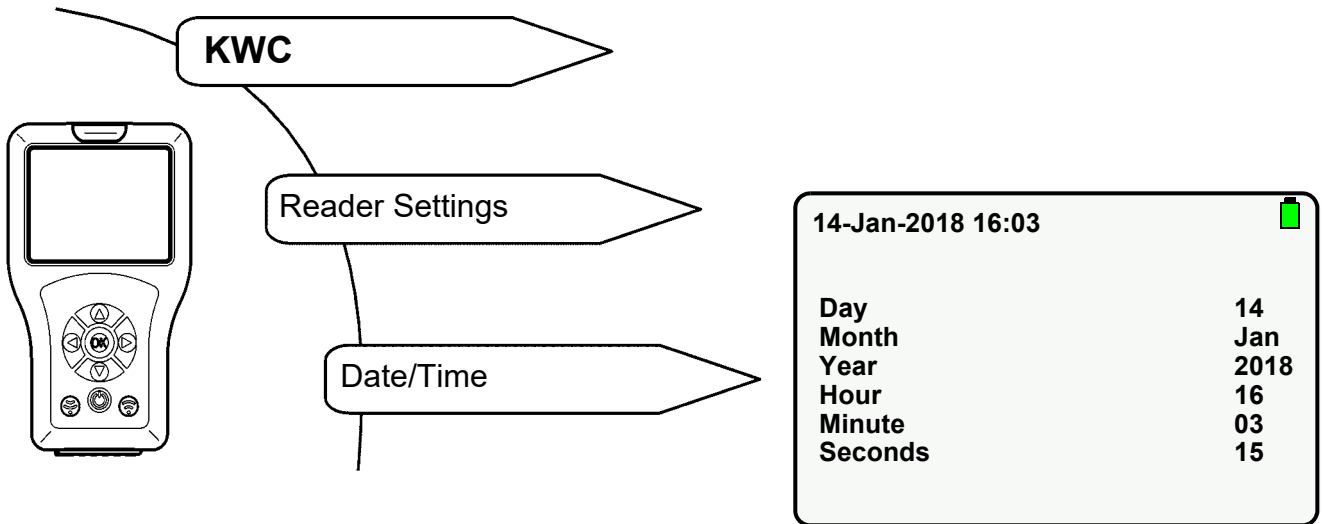

11.1 Select parameters with “ ▲▼ ” buttons.

11.2 Set parameters with “ ◀▶ ” buttons.

11.3 Confirm with “OK” button.

- The settings are stored.

12. System Setting

The following parameters are set in System Setting:

- Language
Language of the display.
- Standby Mode
The display switches off after the pre-set time when the Standby Mode is activated. The Reader goes into Standby Mode.
Press the “” button to exit the Standby Mode.
- Standby Time
Time after which the display switches off.
- Key Beep
Each keypress generates a noise when Key Beep is activated.

The other parameters cannot be changed.

Select the following menu items to go to the destination display:

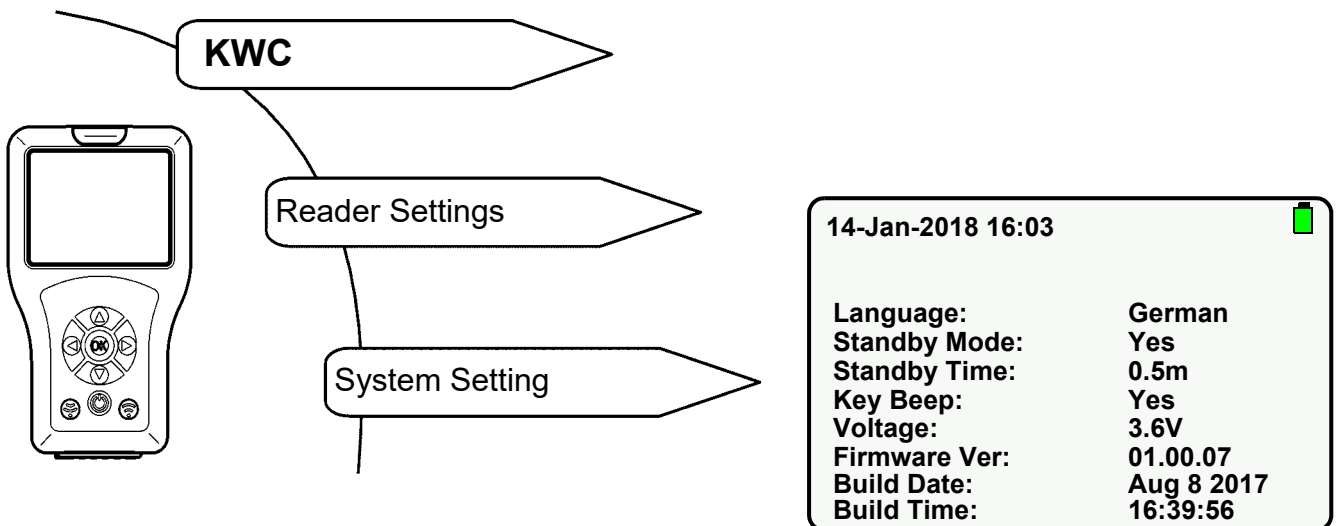

12.1 Select parameters with “ ” buttons.

12.2 Set parameters with “” buttons.

12.3 Confirm with “OK” button.

- The settings are stored.



Important!

Energy is saved when the Standby Mode is activated.

13. USB Mass Storage Mode

The USB Mass Storage Mode connects the Reader to a PC via a USB cable. Data can be

- stored in the Reader (e.g. new firmware)
- or
- loaded from the Reader (e.g. statistical data).



Important!

The Reader must be set to the Mass Storage Mode before it is recognised by the PC as an external drive.

Select the following menu items to go to the destination display:

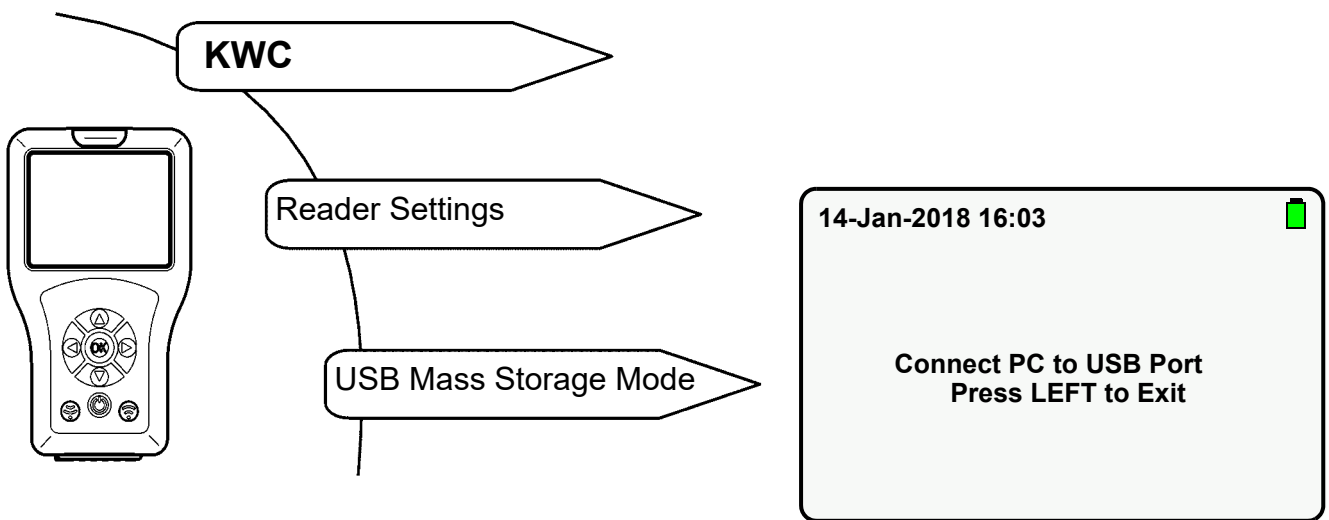

13.1 Insert USB cable in Reader and PC.

13.2 The following display appears:

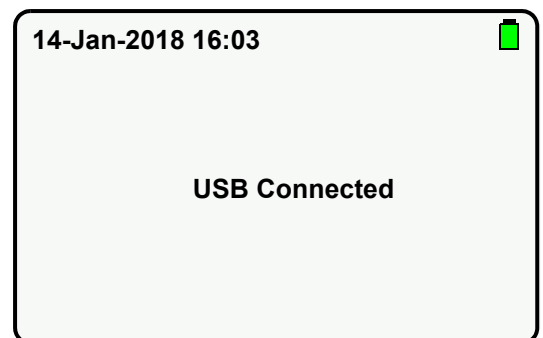

- The Reader is shown as a mass-storage device on the PC.

14. FirmwareUpdate

A new firmware version is selected in the "FirmwareUpdate" menu on the Reader and installed (see Chapter 12).

14.1 Connect the Reader to a PC (siehe [Kapitel 13.](#)).

14.2 Drop the new firmware file in the main folder of the mass-storage device.

14.3 Select the following menu items to go to the destination display:

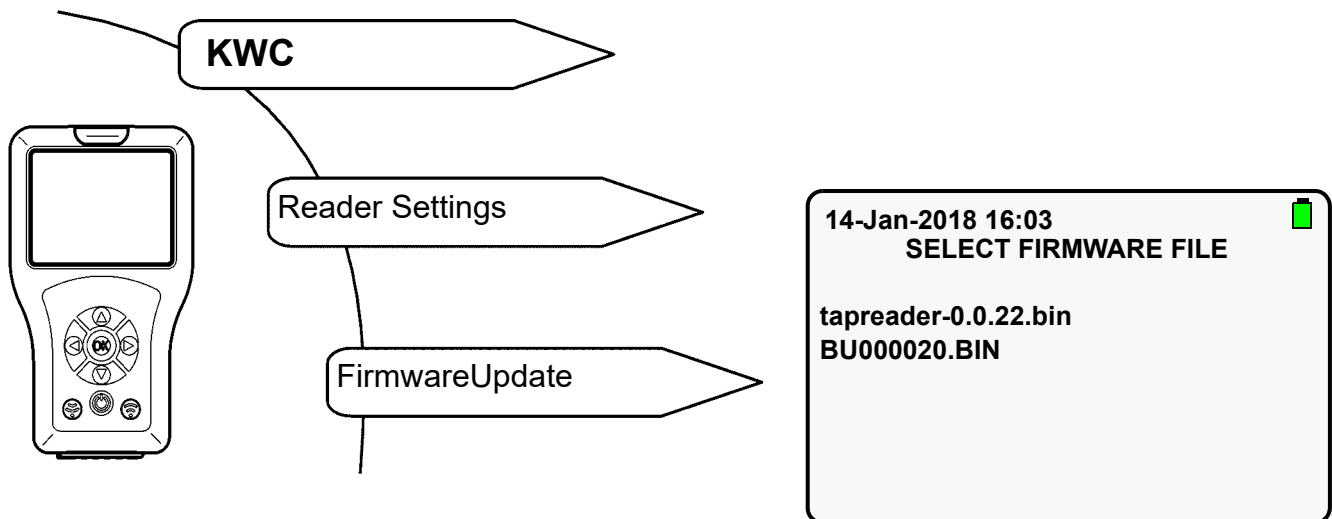

14.4 Select the new FirmwareUpdate with the “ ▲▼ ” buttons.

14.5 Confirm with “OK” button.

14.6 Follow the instructions on the display.

15. Settings Readout

The current settings of the tap are read out and imported to the Reader and displayed.

Select the following menu items to go to the destination display:

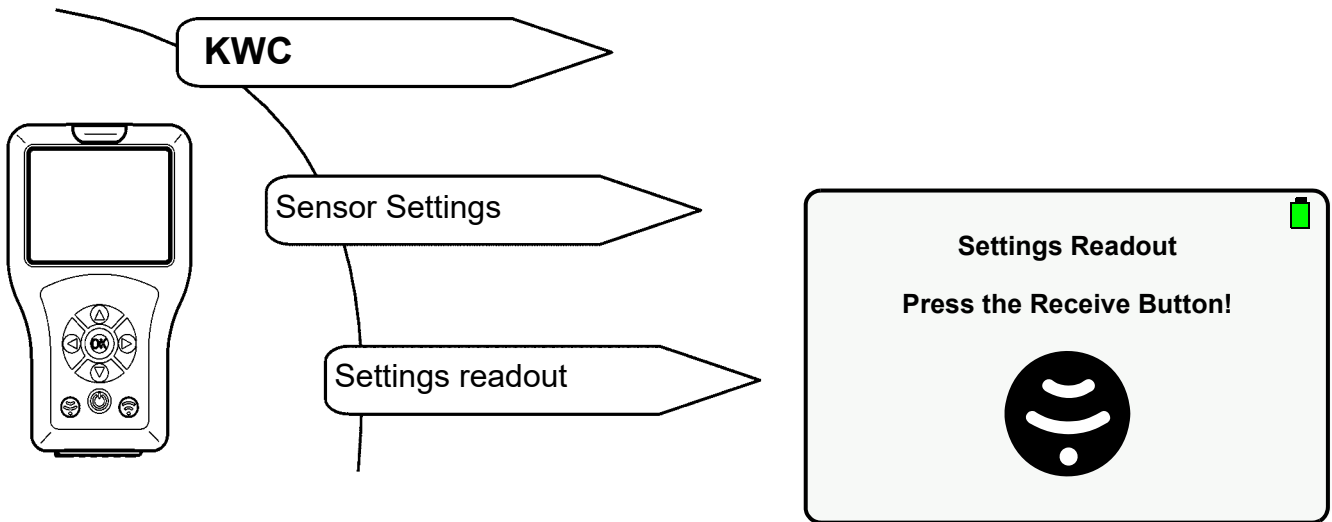

15.1 Press the  button.

- Parameters are read out.

If a connection could not be made, the following display appears:

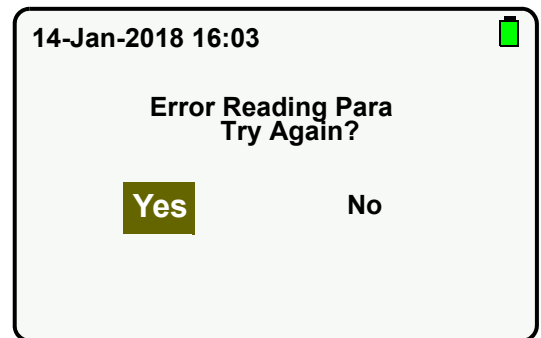

15.2 Confirm with “Yes”.

- Settings are read out.

16. Settings Memory

The altered settings of the tap can be stored in the Reader.

Select the following menu items to go to the destination display:

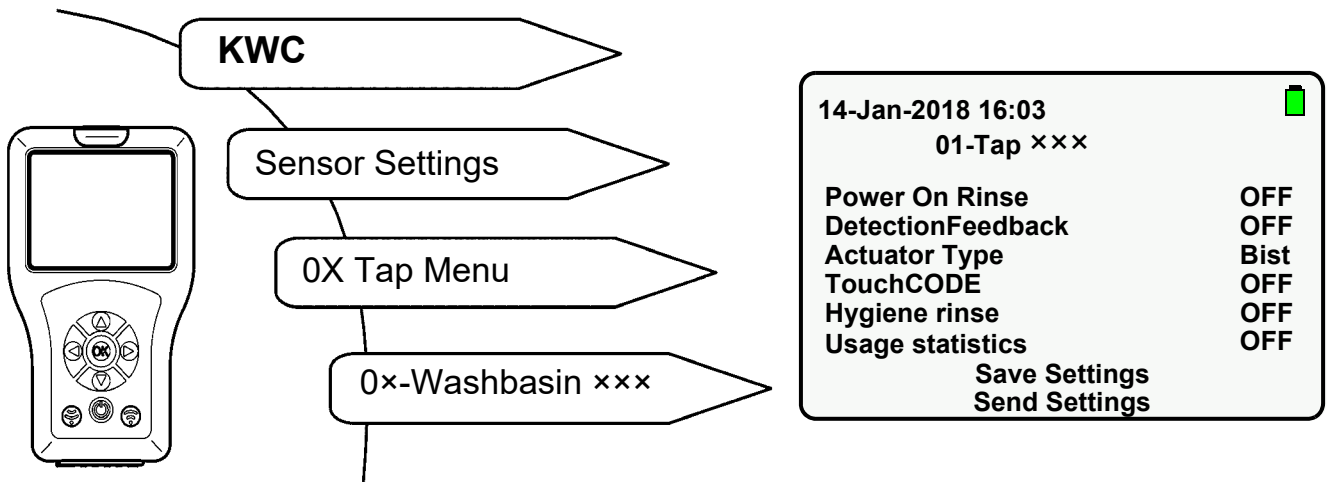

16.1 Navigate to “Save Settings” with the “ ▲▼ ” buttons.

16.2 Confirm with “OK” button.

- Settings are stored.

17. Displaying Stored Settings

Select the following menu items to go to the destination display:

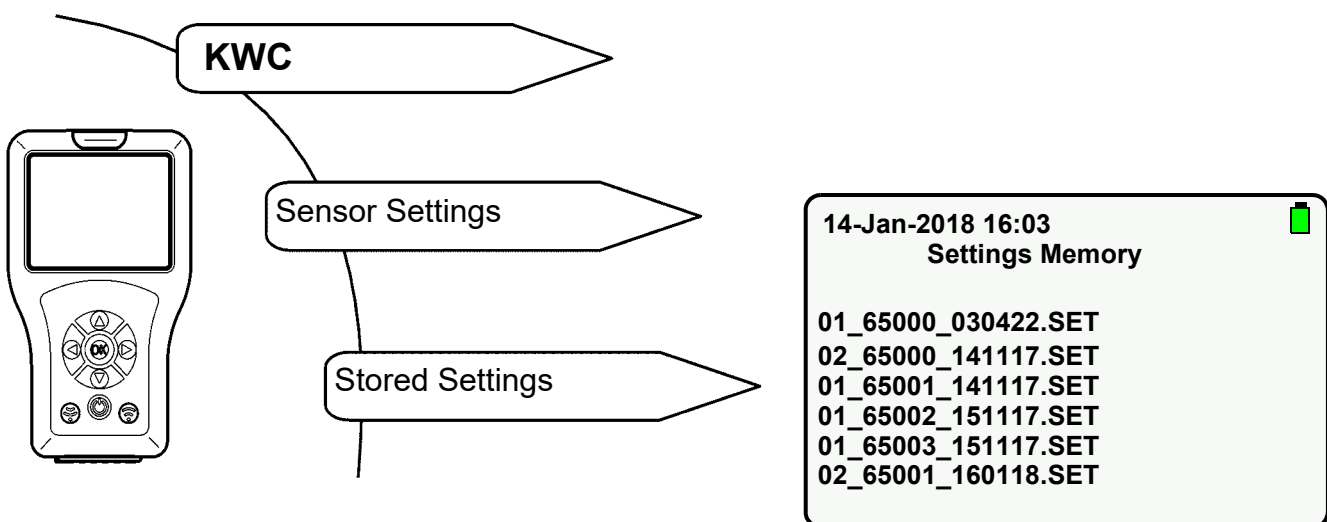

17.1 Select the respective setting with the “ ▲▼ ” buttons.

17.2 Confirm with “OK” button.

- Settings are imported to the Reader and displayed.

18. Sending Settings

The current settings of the Reader can be sent to the tap individually or completely.

Sending an individual setting

18.1 Change the parameter setting (see e.g. [Kapitel 20](#) to [Kapitel 23](#).)

18.2 Press the  button.

Sending the complete settings

18.3 Select the following menu items to go to the destination display:

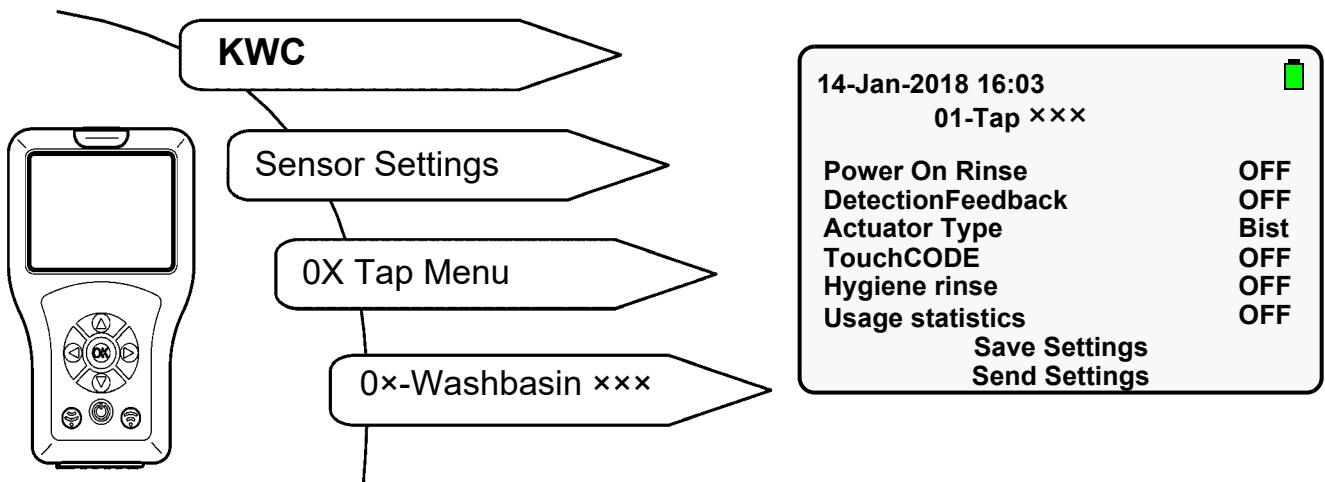

18.4 Navigate to “Send Settings” with the “ ▲▼ ” buttons.

18.5 Confirm with “OK” button.

- All settings are sent to the tap.

19. Deleting Stored Settings

The respective files can be deleted if memory space is required or the settings are no longer required.

Deleting settings via display

19.1 Select the following menu items to go to the destination display:

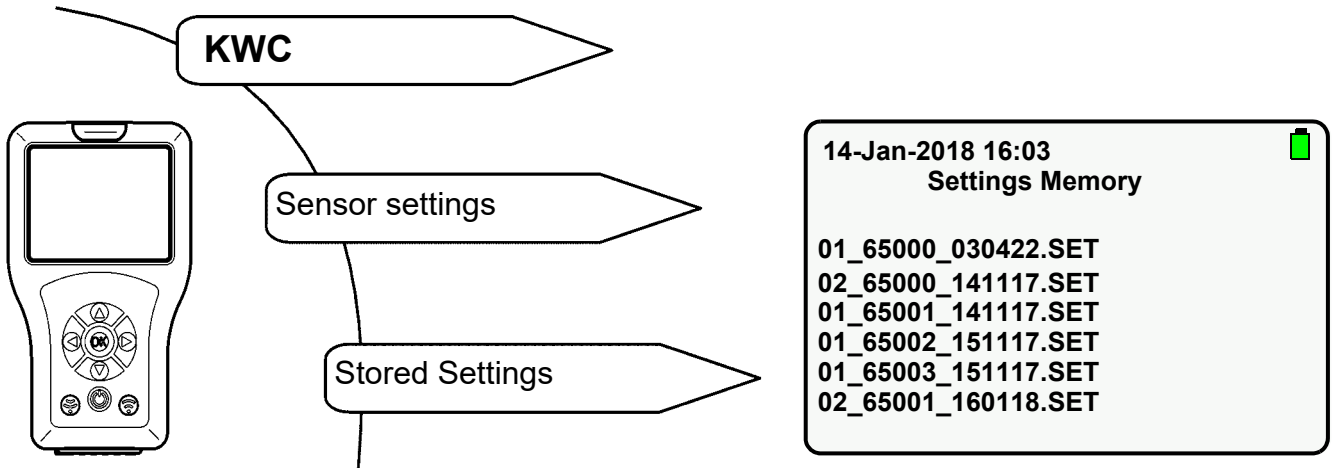

19.2 Select the setting you wish to delete with the “ ▲▼ ” buttons.

19.3 Press and hold down the “OK” button until the following display appears:

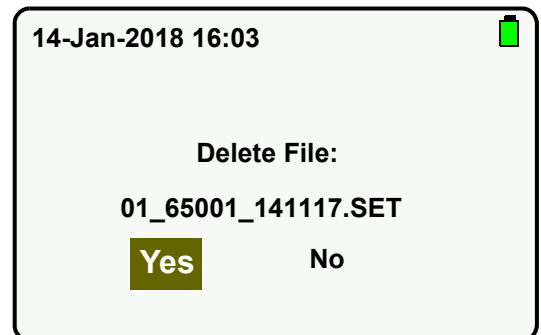

19.4 Confirm with “Yes”.

- The setting is deleted.

Deleting settings via the USB Mass Storage Mode

19.5 Connect the Reader to a PC (siehe [Kapitel 13.](#)).

19.6 Delete the desired file in the “FR_SETTINGS” folder.

20. Setting Flow Time

Important!

Flow Time is only active during sensor operation.

Flow Time is the time during which the water flows after the tap has been triggered.

Select the following menu items to go to the destination display:

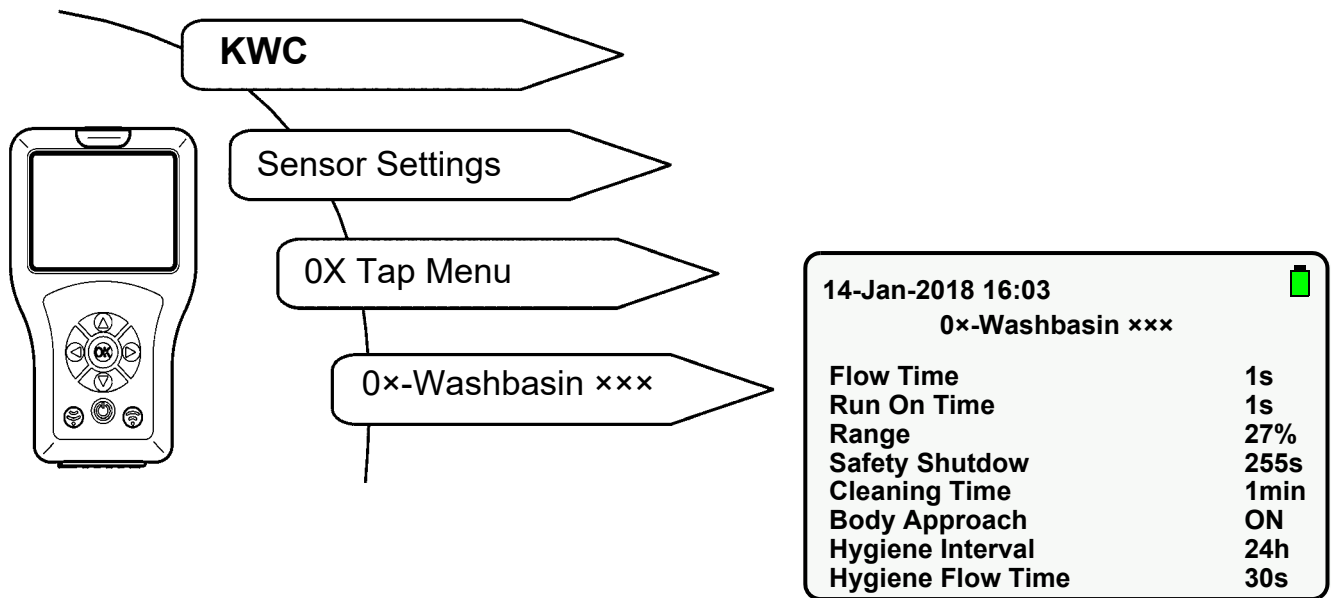

20.1 Select "Flow Time" with " ▲▼ " buttons.

20.2 Press the "OK" button.

20.3 Select "Flow Time" with " ▲▼ " buttons (1-255s).

20.4 Confirm with "OK" button.

20.5 Press the  button.

- The parameter change is sent to the tap

21. Setting Run On Time

Important!

Run On Time is only active during sensor operation.

Run On Time is the time during which the water flows after the detection area has been left.

Select the following menu items to go to the destination display:

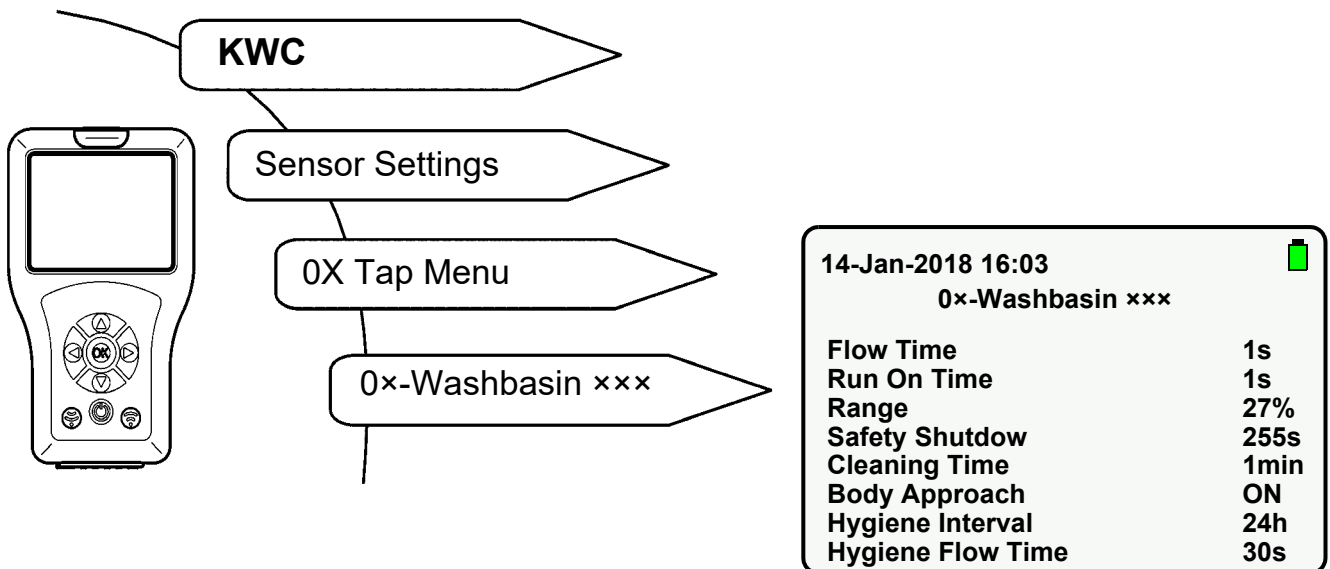

21.1 Select "Run On Time" with " ▲▼ " buttons.

21.2 Press the "OK" button.

21.3 Select "Run On Time" with " ▲▼ " buttons (1-255s).

21.4 Confirm with "OK" button.

21.5 Press the  button.

- The parameter change is sent to the tap

22. Setting Range

Range is the distance within which the body can be detected by the sensor. Range can be set from 0-100%.

- Approx. 300 mm is equivalent to 100% in the F3 tap series.
- Approx. 700 mm is equivalent to 100% in the F5 tap series.

Select the following menu items to go to the destination display:

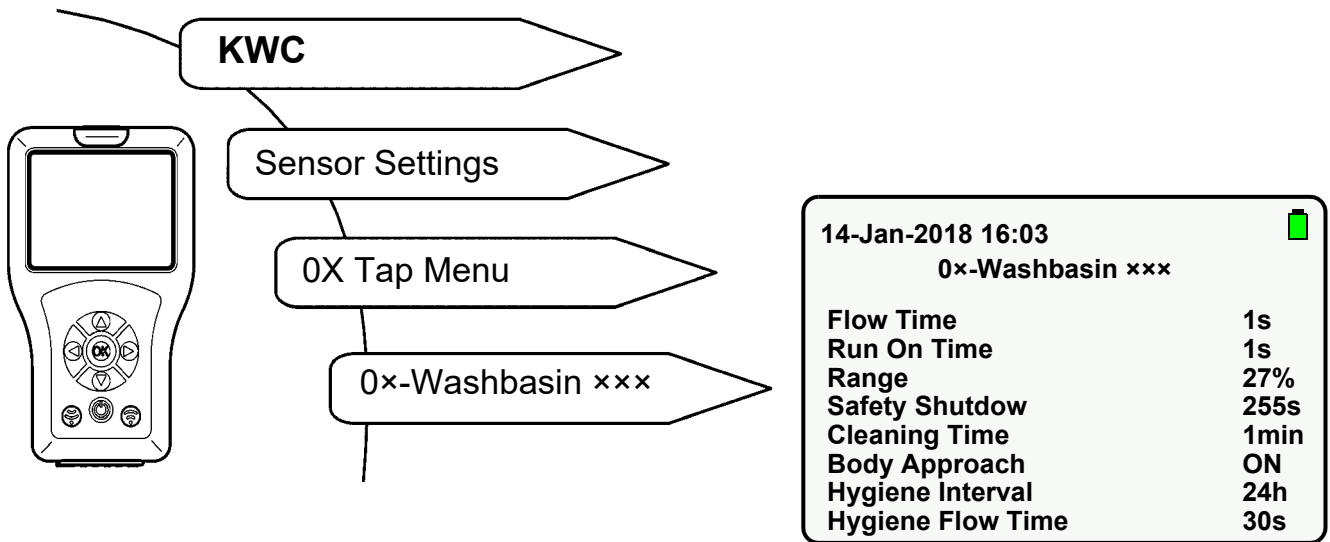

22.1 Select "Range" with " ▲▼ " buttons.

22.2 Press the "OK" button.

22.3 Select "Range" with " ▲▼ " buttons (0-100%).

22.4 Confirm with "OK" button.

22.5 Press the  button.

- The parameter change is sent to the tap.

23. Setting Mode of Operation

The following modes of operation can be set:

- ON
- OFF (tap only reacts to the Reader)
- STB (tap only reacts to the Reader, and the hygiene purge is executed when this function is activated)

Select the following menu items to go to the destination display:

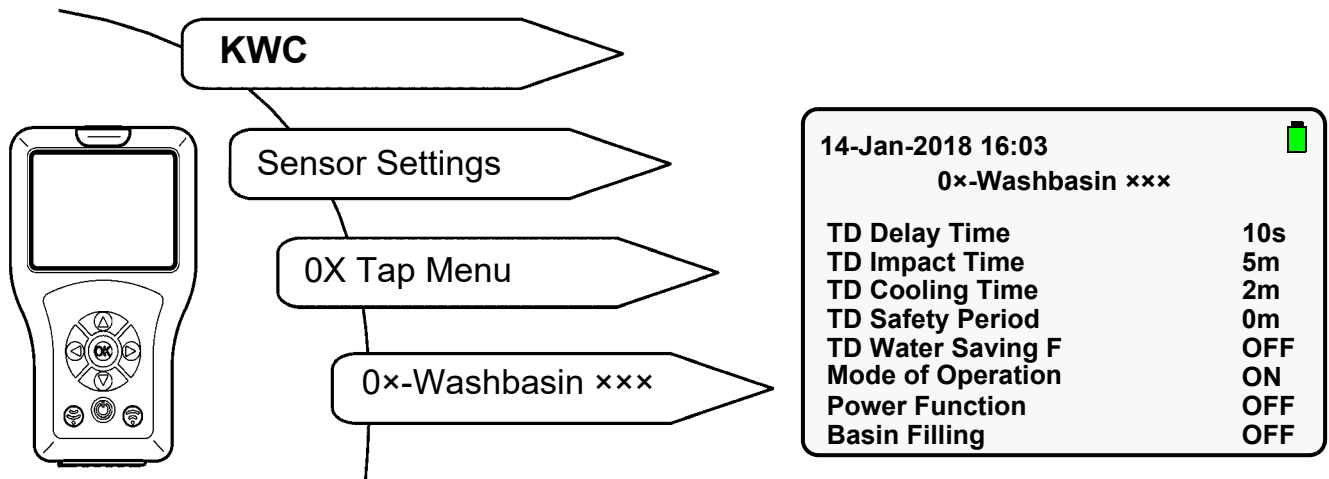

23.1 Select "Mode of Operation" with " ▲▼ " buttons.

23.2 Press the "OK" button.

23.3 Select "Mode of Operation" with " ▲▼ " buttons (ON, OFF, STB).

23.4 Confirm with "OK" button.

23.5 Press the  button.

- The parameter change is sent to the tap.

24. Activating Power Function

☞ This function generates higher energy consumption at the tap.

When Power Function is activated, the detection area is scanned by the tap sensor approx. 10 times more frequently.

Select the following menu items to go to the destination display:

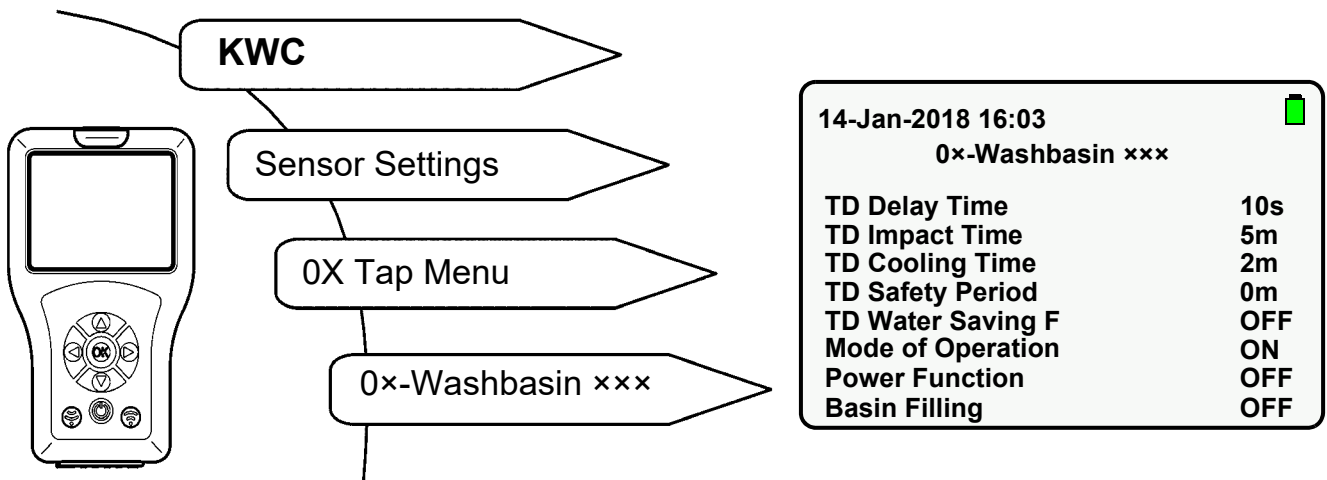

24.1 Select "Power Function" with " ▲▼ " buttons.

24.2 Press the "OK" button.

24.3 Set "Power Function" to "ON" with " ▲▼ " buttons.

24.4 Confirm with "OK" button.

24.5 Press the  button.

- The parameter change is sent to the tap.

25. Activating Power On Rinse

When Power On Rinse is activated, the tap is rinsed after the operating voltage has been applied. The Flow Time corresponds to the pre-set flow and Run On Time.

Select the following menu items to go to the destination display:

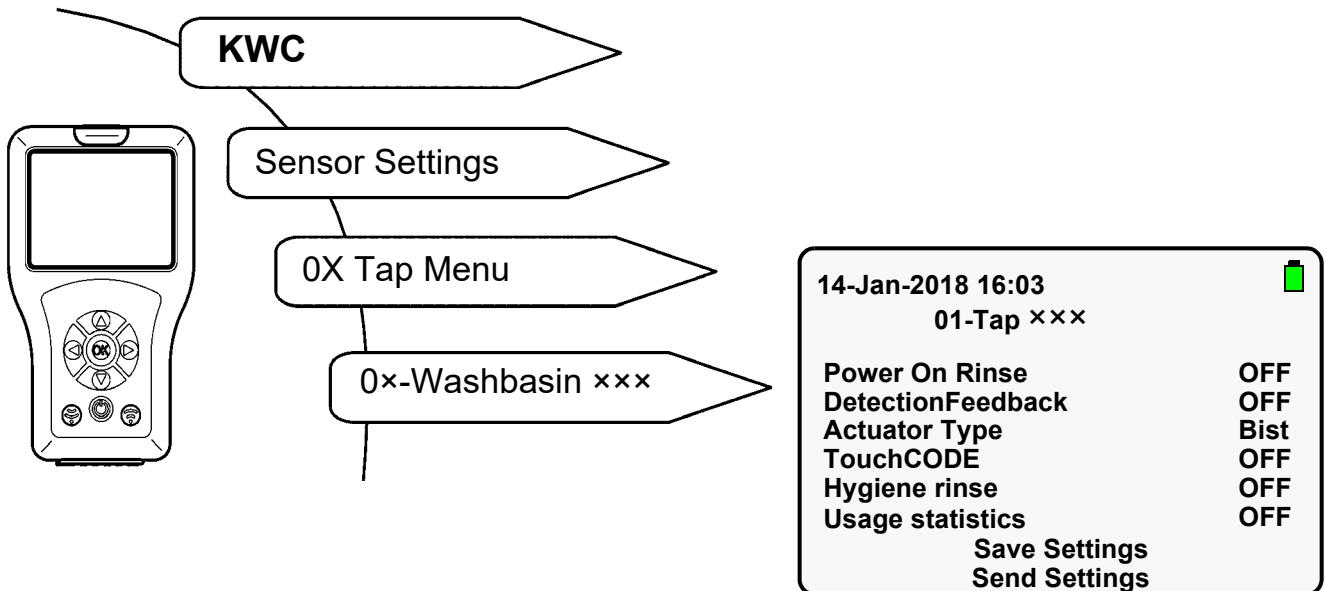

25.1 Select “Power On Rinse” with “ ▲▼ ” buttons.

25.2 Press the “OK” button.

25.3 Set “Power On Rinse” to “ON” with “ ▲▼ ” buttons.

25.4 Confirm with “OK” button.

25.5 Press the  button.

- The parameter change is sent to the tap.

26. Activating TouchCODE

When the TouchCODE function is activated,

- the hygiene purge can be switched on or off by hand within one minute after the operating voltage has been applied (siehe [Kapitel 36.](#)).
- the basin filling function (continuous operation) can be started (siehe [Kapitel 33.](#)).

Select the following menu item to go to the destination display:

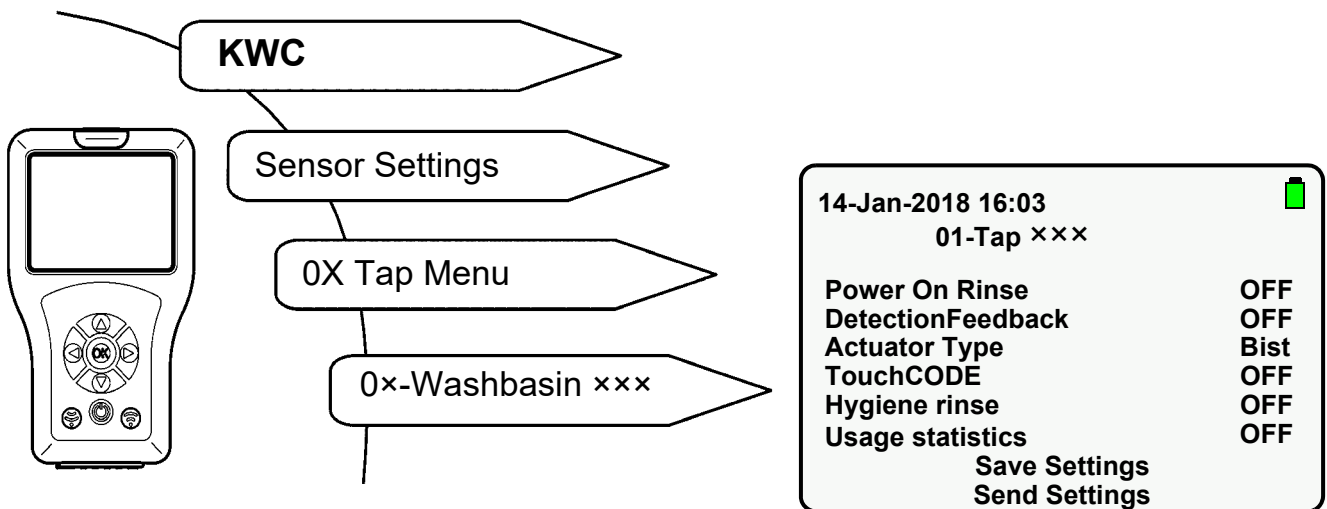

26.1 Select "TouchCODE" with " ▲▼ " buttons.

26.2 Press the "OK" button.

26.3 Set "TouchCODE" to "ON" with " ▲▼ " buttons.

26.4 Confirm with "OK" button.

26.5 Press the  button.

- The parameter change is sent to the tap.

27. Setting Cleaning Time

When Cleaning Time is activated, the tap only reacts to the Reader for the specified time.

Select the following menu items to go to the destination display:

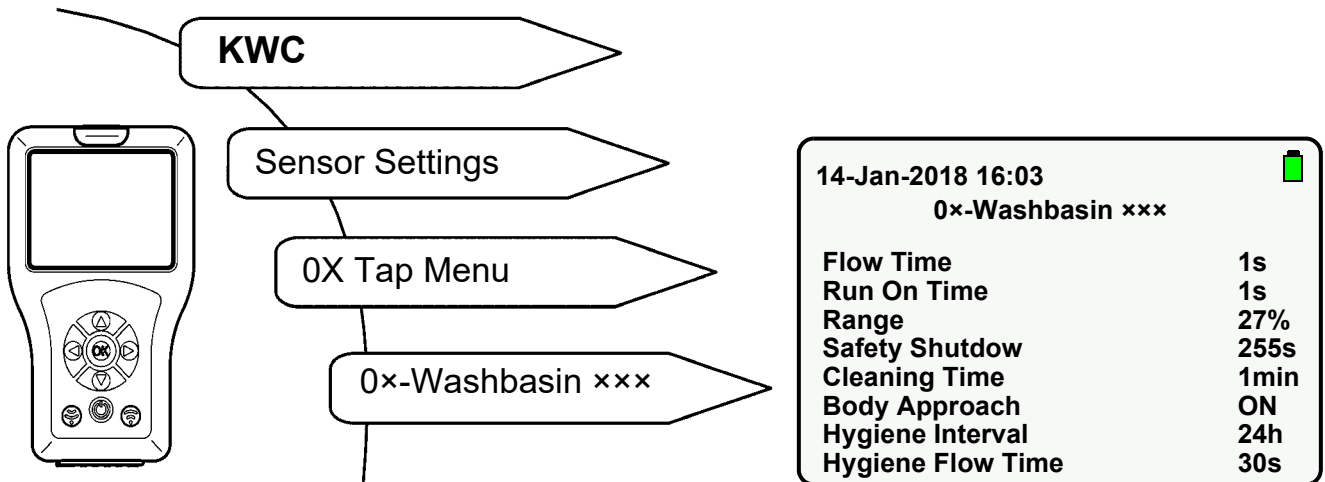

27.1 Select "Cleaning Time" with " ▲▼ " buttons.

27.2 Press the "OK" button.

27.3 Select "Turn-Off Time" with " ▲▼ " buttons (1-255 min).

27.4 Confirm with "OK" button.

27.5 Press the button.

- The parameter change is sent to the tap.

28. Switching on Cleaning Time

When Cleaning Time is activated, the tap only reacts to the Reader for the input time.

Select the following menu items to go to the destination display:

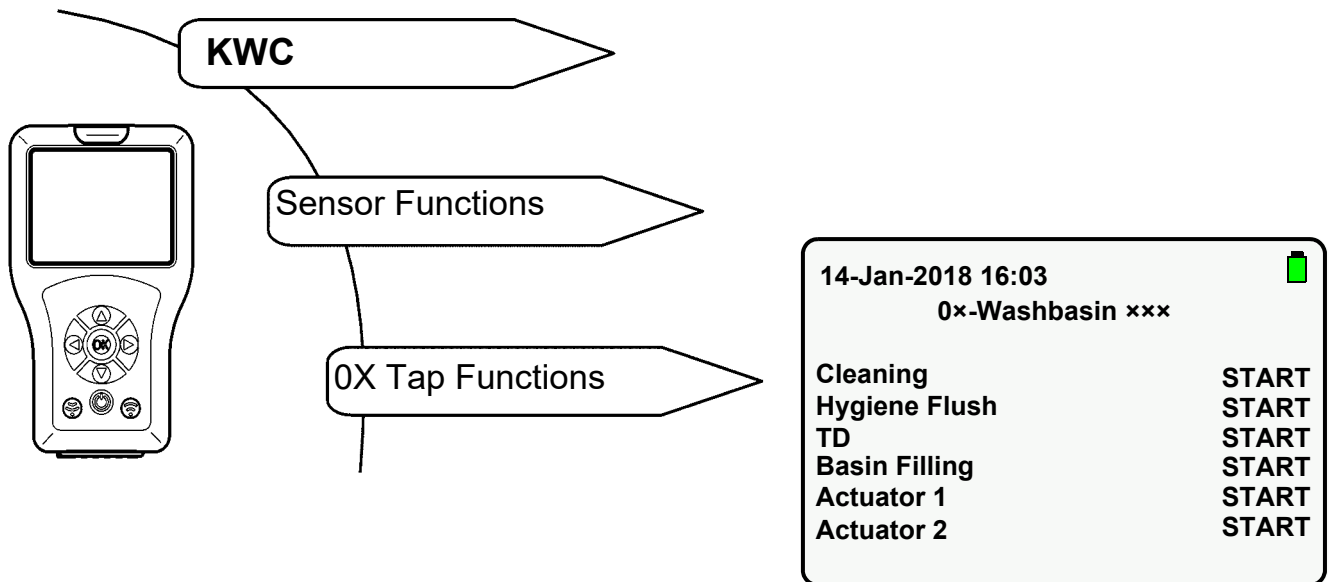

28.1 Select “Cleaning” with “ ▲▼ ” buttons.

28.2 Press the “OK” button.

28.3 Set “Cleaning” to “START” with “ ▲▼ ” buttons.

28.4 Confirm with “OK” button.

28.5 Press the button.

- The tap is deactivated for the pre-set time.
- The sensor LED flashes green every 10 s.

Only the selected action is executed.

The Cleaning Time function can be ended ahead of time.

28.6 Select “Cleaning” with “ ▲▼ ” buttons.

28.7 Press the “OK” button.

28.8 Set “Cleaning” to “STOP” with “ ▲▼ ” buttons.

28.9 Confirm with “OK” button.

28.10 Press the button.

- Cleaning Time is ended.

29. Setting Safety Shutdown

The tap switches off after the pre-set time in the event of continuous activation.

Select the following menu items to go to the destination display:

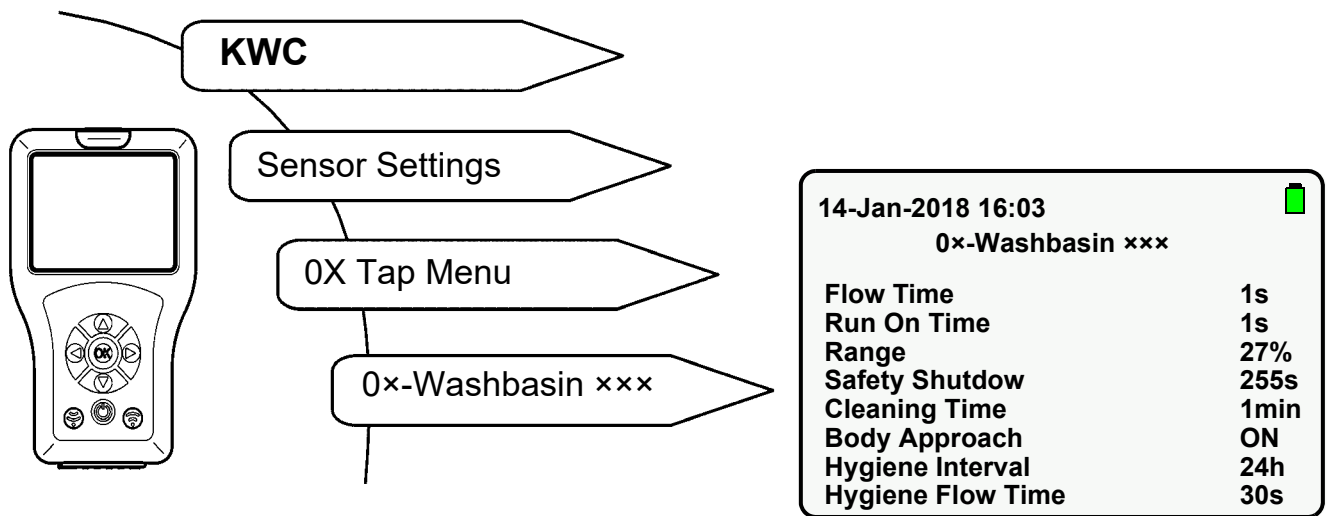

29.1 Select "Safety Shutdown" with " ▲▼ " buttons.

29.2 Press the "OK" button.

29.3 Select "Turn-Off Time" with " ▲▼ " buttons (1-255s).

29.4 Confirm with "OK" button.

29.5 Press the  button.

- The parameter change is sent to the tap.

30. Switching off the tap

The tap can be permanently switched off.

This corresponds to the Off mode of operation (siehe [Kapitel 23.](#)).

31. Switching on the Basin Filling function

When the Basin Filling function is activated, basin filling (continuous operation) can be started with the Reader.

When the Basin Filling and TouchCODE functions are activated, basin filling (continuous operation) can be started by hand one minute after the operating voltage has been applied (see instructions for the taps).

Select the following menu items to go to the destination display:

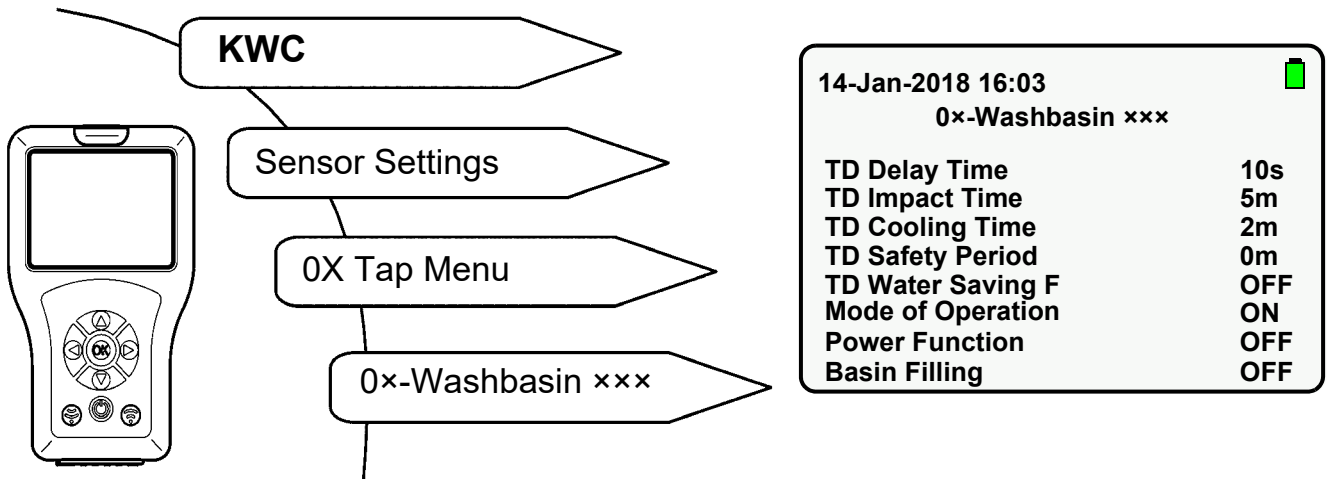

- 31.1 Select "Basin Filling" with " ▲▼ " buttons.
- 31.2 Press the "OK" button.
- 31.3 Set "Basin Filling" to "ON" with " ▲▼ " buttons.
- 31.4 Confirm with "OK" button.
- 31.5 Press the button.
 - The parameter change is sent to the tap.

32. Setting Basin Filling/Continuous Operation

The Basin Filling Time is the time during which the water flows after the Basin Filling function has been started.

Select the following menu items to go to the destination display:

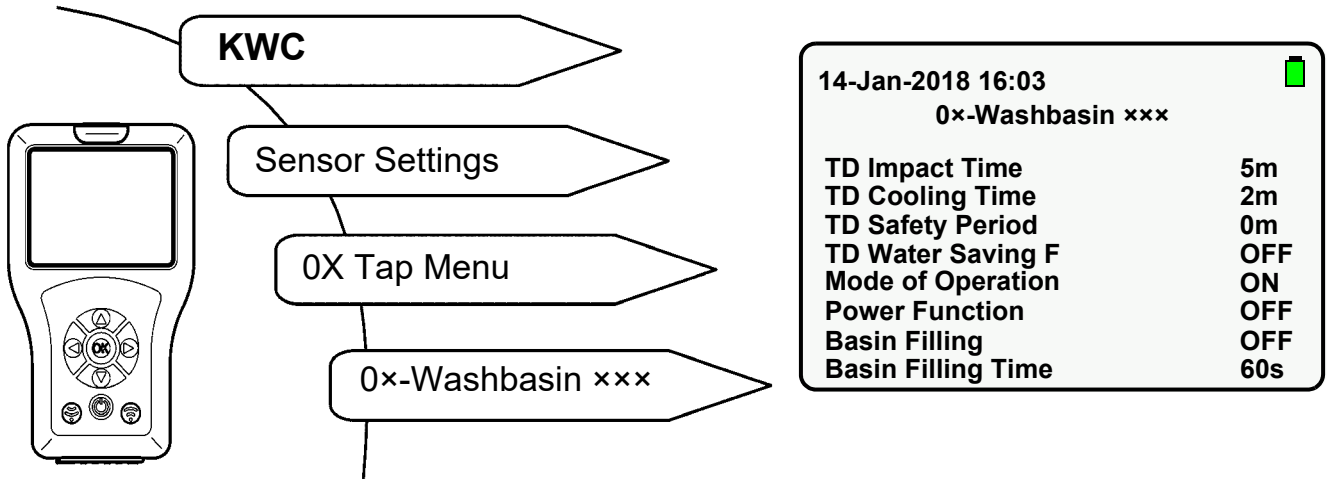

32.1 Select "Basin Filling Time" with " ▲▼ " buttons.

32.2 Press the "OK" button.

32.3 Set the "Basin Filling Time" with " ▲▼ " buttons (0-255s).

32.4 Confirm with "OK" button.

32.5 Press the  button.

- The parameter change is sent to the tap.

33. Starting Basin Filling/Continuous Operation

When the Basin Filling function is started, the water flows for the pre-set time.

Select the following menu items to go to the destination display:

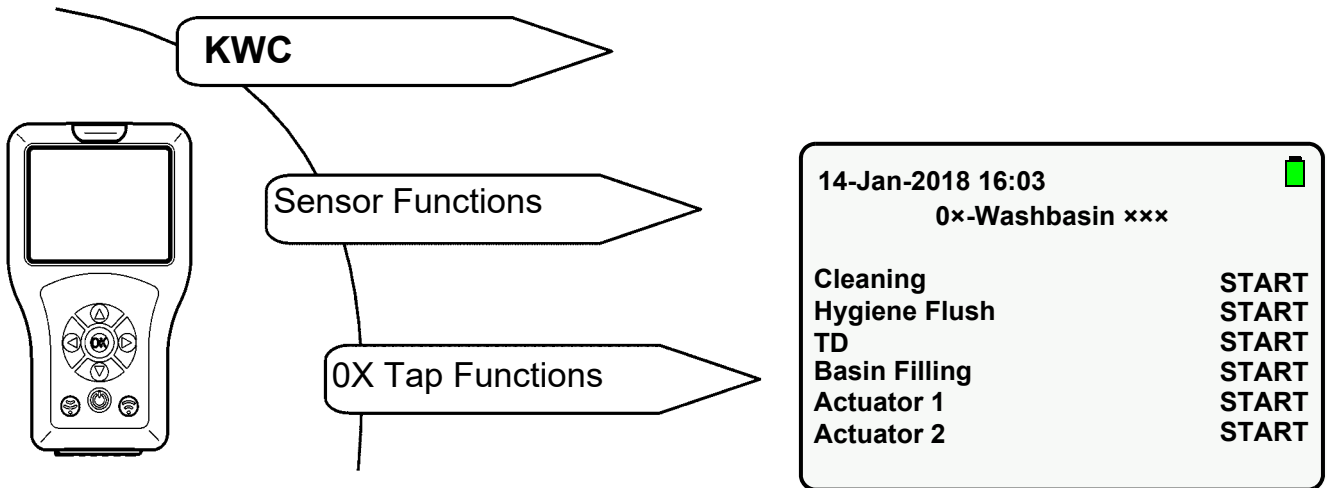

33.1 Select "Basin Filling" with " ▲▼ " buttons.

33.2 Press the "OK" button.

33.3 Set "Basin Filling" to "START" with " ▲▼ " buttons.

33.4 Confirm with "OK" button.

33.5 Press the  button.

- The water flows for the pre-set time.

 Only the selected action is executed.

 The Basin Filling function can be ended ahead of time.

33.6 Select "Basin Filling" with " ▲▼ " buttons.

33.7 Press the "OK" button.

33.8 Set "Basin Filling" to "STOP" with " ▲▼ " buttons.

33.9 Confirm with "OK" button.

33.10 Press the  button.

- The Basin Filling/Continuous Operation function is ended.

34. Switching on DetectionFeedback

When the DetectionFeedback function is activated, a body in the detection area is detected.

When a body is detected in the detection area,

- the sensor LED lights up green.
- the tap is triggered.

Select the following menu items to go to the destination display:

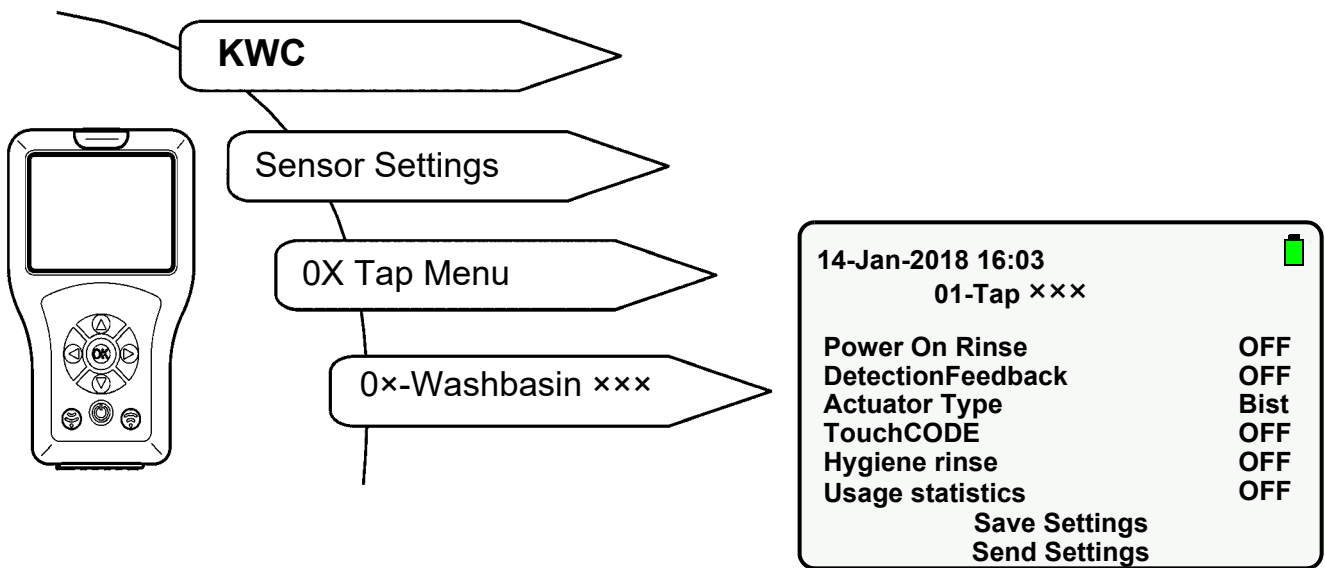

34.1 Select "DetectionFeedback" with " ▲▼ " buttons.

34.2 Press the "OK" button.

34.3 Set "DetectionFeedback" to "ON" with " ▲▼ " buttons.

34.4 Confirm with "OK" button.

34.5 Press the  button.

- The parameter change is sent to the tap.

35. Switching on Body Approach

 This function is only available in the F5 tap series.

When the Body Approach function is activated, a body is detected within the max. detection range of 700 mm.

When a body is detected in the detection area,

- the sensor LED lights up green.
- the tap is not triggered.

Select the following menu items to go to the destination display:

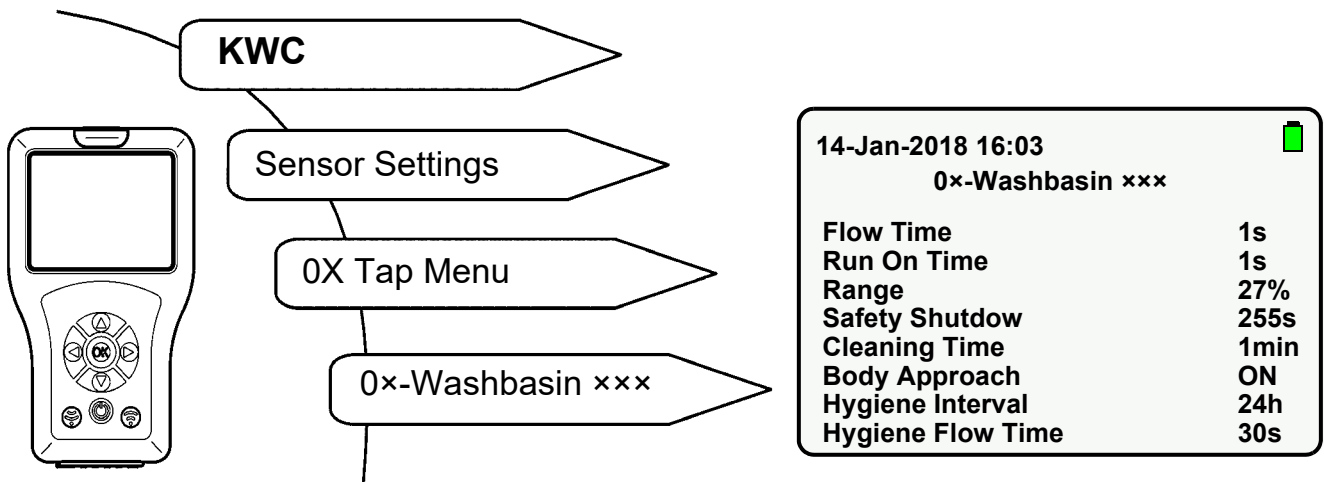

35.1 Select “Body Approach” with “ ▲▼ ” buttons.

35.2 Press the “OK” button.

35.3 Set “Body Approach” to “ON” with “ ▲▼ ” buttons.

35.4 Confirm with “OK” button.

35.5 Press the  button.

- The parameter change is sent to the tap.

36. Switching Hygiene Purge on/off

When the Hygiene Purge function is activated, water flows for the pre-set time after the pre-set interval after the last usage.

Select the following menu items to go to the destination display:

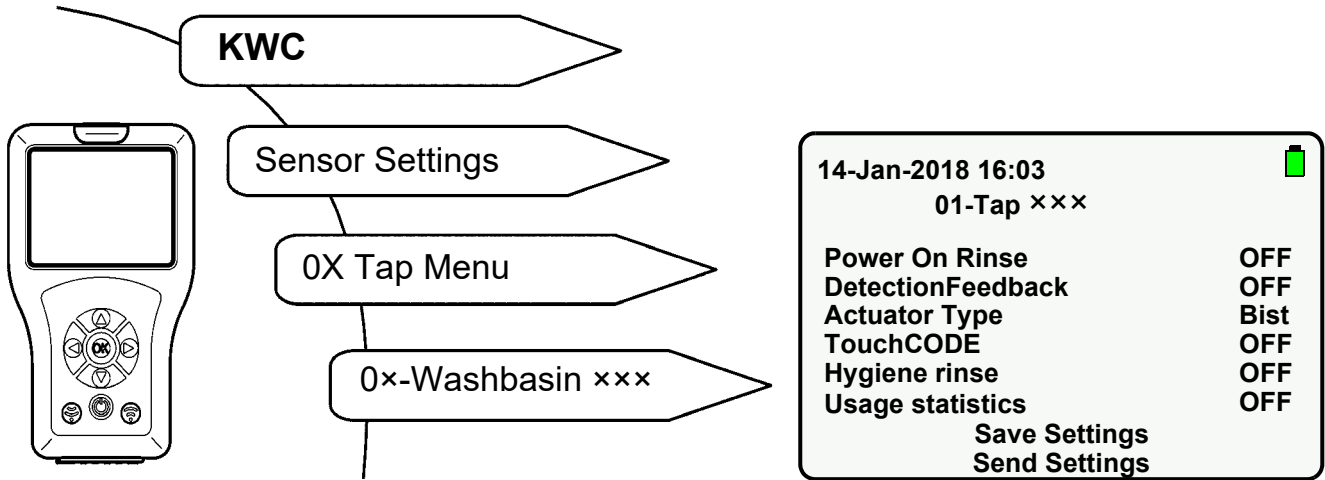

36.1 Select “Hygiene Purge” with “ ▲▼ ” buttons.

36.2 Press the “OK” button.

36.3 Set “Hygiene Purge” to “ON” or “OFF” with “ ▲▼ ” buttons.

36.4 Confirm with “OK” button.

36.5 Press the  button.

- The parameter change is sent to the tap.

37. Setting Hygiene Interval

Tap F3/F5

Hygiene Interval is the time after which the tap is automatically triggered after the last usage.

ACLM Hygiene Unit

Hygiene Interval is the time after which the tap is automatically triggered after the last Hygiene Purge.

Select the following menu items to go to the destination display:

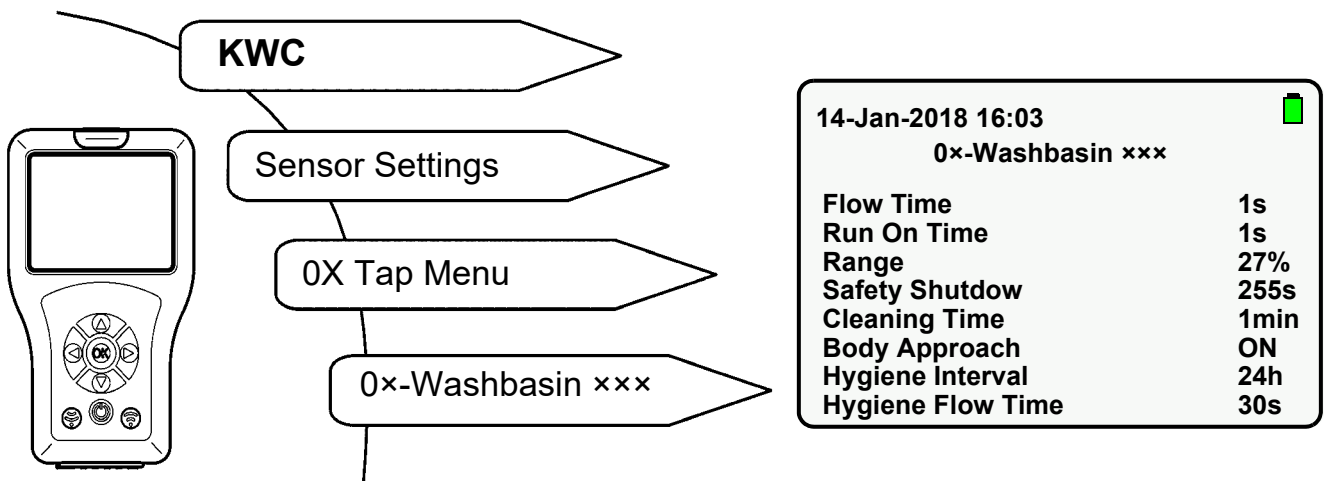

37.1 Select "Hygiene Interval" with " ▲▼ " buttons.

37.2 Press the "OK" button.

37.3 Select "Hygiene Interval" with " ▲▼ " buttons (0-255s).

37.4 Confirm with "OK" button.

37.5 Press the  button.

- The parameter change is sent to the tap.

38. Setting Hygiene Flow Time

Hygiene Flow Time is the time during which water flows after the Hygiene Purge has been triggered.

Select the following menu items to go to the destination display:

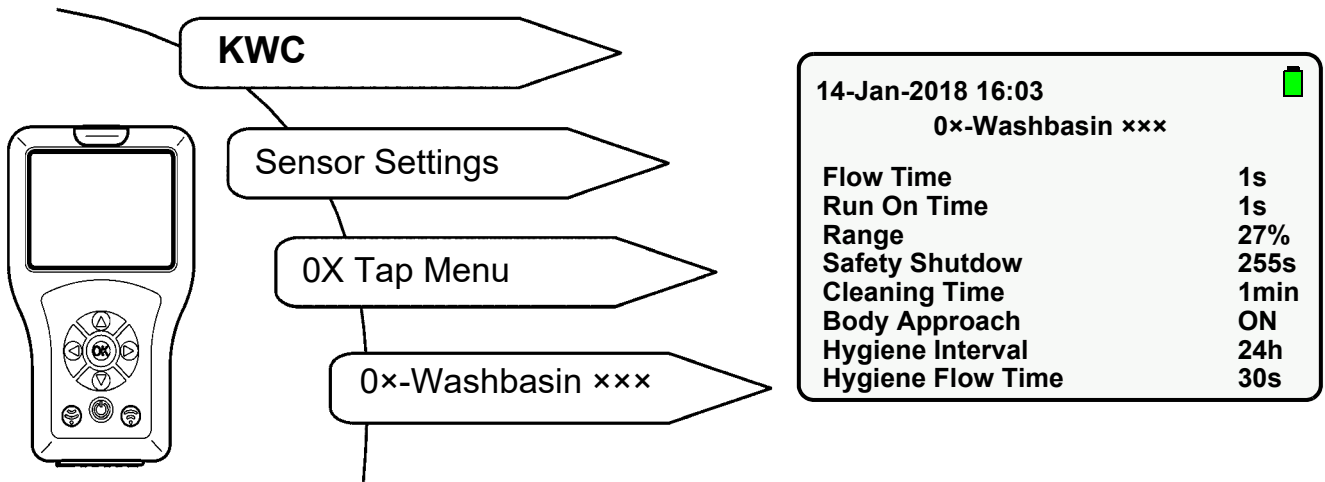

38.1 Select "Hygiene Flow Time" with " ▲▼ " buttons.

38.2 Press the "OK" button.

38.3 Select "Hygiene Flow Time" with " ▲▼ " buttons (0-255s).

38.4 Confirm with "OK" button.

38.5 Press the  button.

- The parameter change is sent to the tap.

39. Starting Hygiene Purge

Hygiene Purge can be started manually if required.

Select the following menu items to go to the destination display:

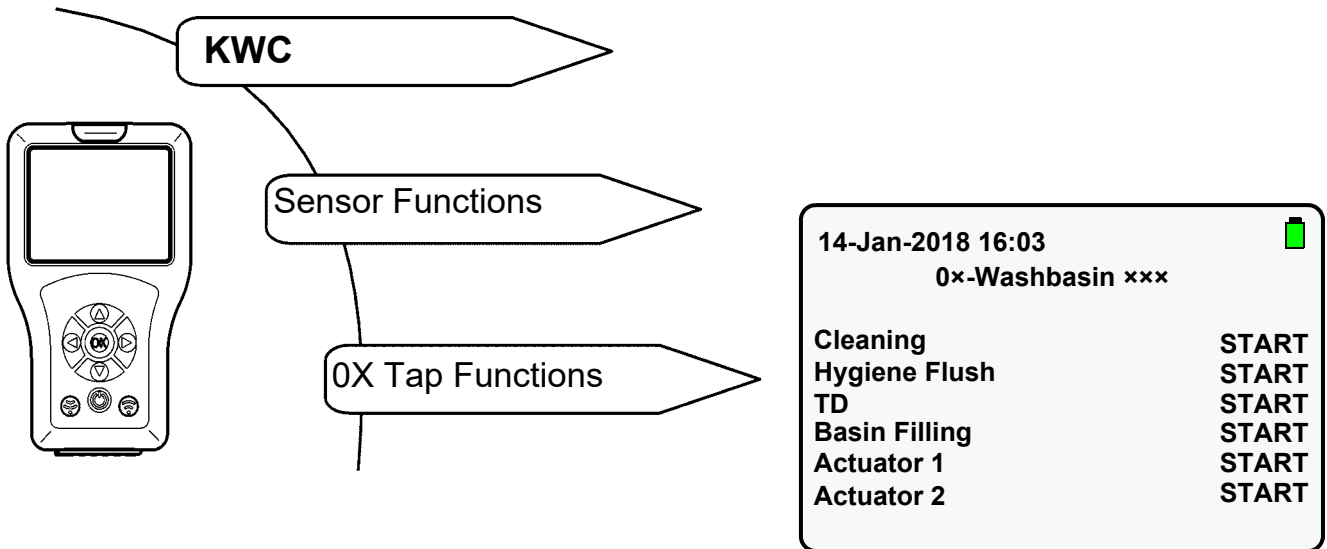

39.1 Select "Hygiene Flush" with " ▲▼ " buttons.

39.2 Press the "OK" button.

39.3 Set to "START" with " ▲▼ " buttons.

39.4 Confirm with "OK" button.

39.5 Press the  button.

- Hygiene Flush starts.

 Only the selected action is executed.

 Hygiene Flush can be ended ahead of time.

39.6 Select "Hygiene Flush" with " ▲▼ " buttons.

39.7 Press the "OK" button.

39.8 Set to "STOP" with " ▲▼ " buttons.

39.9 Confirm with "OK" button.

39.10 Press the  button.

- Hygiene Flush is ended.

40. Requests for thermal disinfection

DVGW Code of Practice W 551 is the basis for carrying out the thermal disinfection. The thermal disinfection should cover the entire system including all extraction taps. All wetted interior surfaces of a drinking water installation system (e.g. shower head material temperature) must be heated to at least 70 °C for more than 3 minutes.

The water in the water heater must therefore be heated to 85 °C.

The outlet temperature (properly speaking, the surface temperature) must be checked at each extraction point.

All the extraction points must be closed during the heating phase of the water heater, so that the complete system (hot water and circulation line) is covered by this measure in circulation systems. The circulation pump must be run in continuous operation. This operating state is maintained until a temperature of $\geq 70^{\circ}\text{C}$ is reached in the circulation water.

Only then are the extraction points flushed in turn with the outlet open.

The thermal disinfection must be carried out section by section depending on the size of the installation and the pipe run. The individual sections must be thermally disinfected in direct succession, in order to exclude recontamination of the installation.

The thermal disinfection may have to be interrupted until the water has been heated up again by the water heater.

The installation must be returned to normal operation after thermal disinfection has been completed. In this respect, each tap must be actuated, in order to drain hot water ($> 43^{\circ}\text{C}$).



Warning!

Personal protective measures (scald protection) must be implemented for the duration of the thermal disinfection. This might include cordoning off the shower facilities.

Failure to observe this instruction can result in injuries due to scalding.

The operator is responsible for the execution, monitoring, and logging (room, tapping point, date, time, temperature and duration).

The manufacturer does not accept any liability for claims by third parties relating to the improper execution of thermal disinfection on the part of the operator.

41. Setting TD Delay Time

Delay Time is the period between the start command and the actual start of the thermal disinfection.

Select the following menu items to go to the destination display:

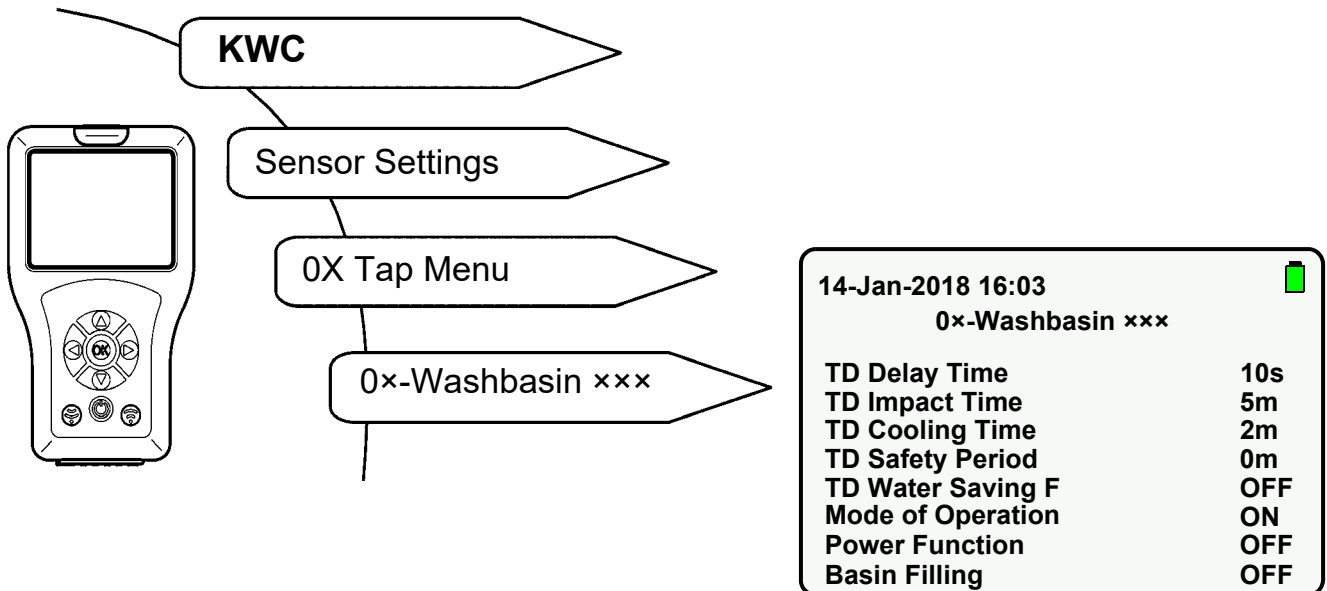

41.1 Select "TD Delay Time" with " ▲▼ " buttons.

41.2 Press the "OK" button.

41.3 Set "TD Delay Time" with " ▲▼ " buttons (0-255 s).

41.4 Confirm with "OK" button.

41.5 Press the  button.

- The parameter change is sent to the tap.

42. Setting TD Impact Time

Impact Time is the period during which the surface of the material is treated with an elevated water temperature.

Select the following menu items to go to the destination display:

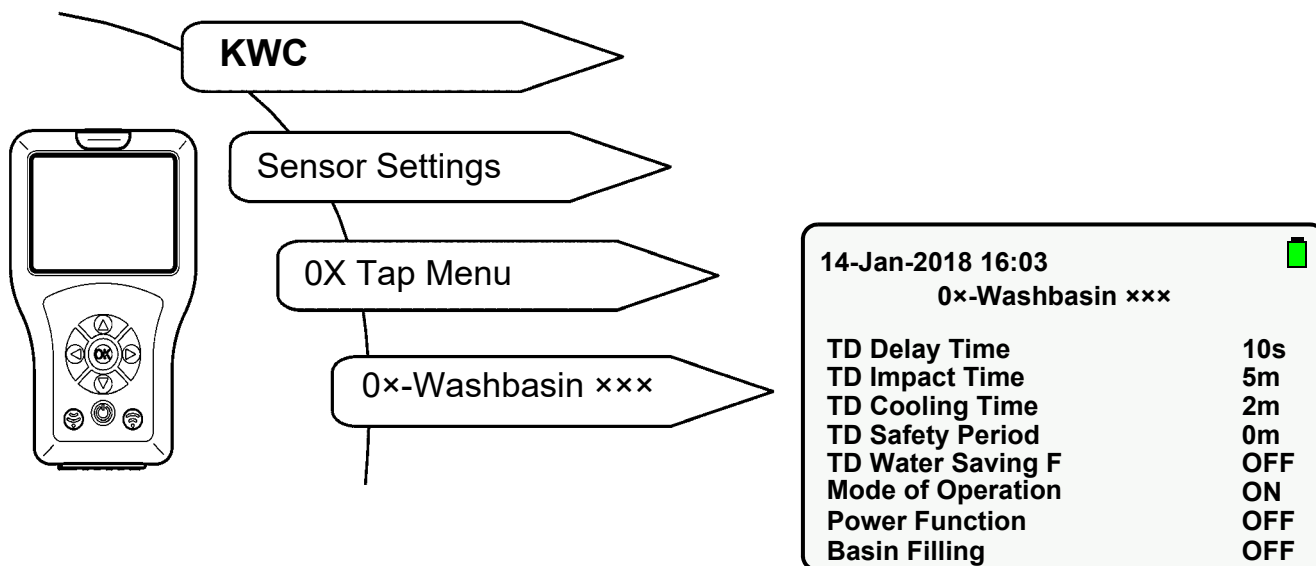

42.1 Select "TD Impact Time" with " ▲▼ " buttons.

42.2 Press the "OK" button.

42.3 Set "TD Impact Time" with " ▲▼ " buttons (0-255 min).

42.4 Confirm with "OK" button.

42.5 button.

- The parameter change is sent to the tap.

43. Setting TD Cooling Time

Cooling Time is the period during which the water has reached the normal use temperature at the tap.

Select the following menu items to go to the destination display:

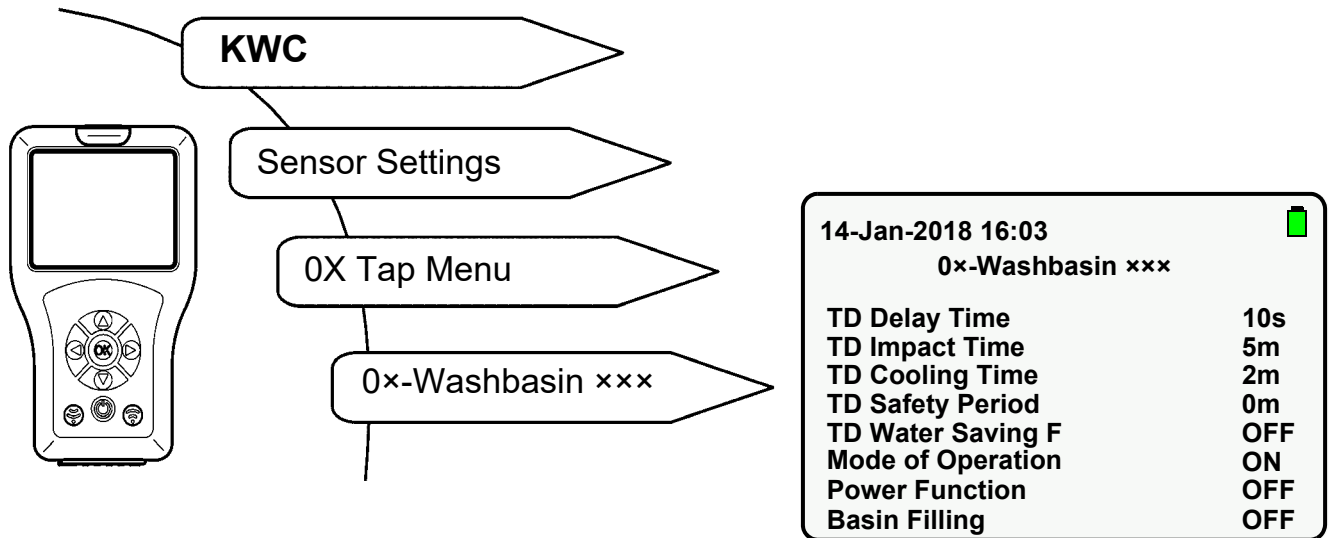

43.1 Select "TD Cooling Time" with " ▲▼ " buttons.

43.2 Press the "OK" button.

43.3 Set "TD Cooling Time" with " ▲▼ " buttons (0-255 min).

43.4 Confirm with "OK" button.

43.5 Press the  button.

- The parameter change is sent to the tap.

44. Setting TD Safety Period

Safety Period is the period between TD Impact Time and TD Cooling Time which is required to bring the drinking water supply system to the normal temperature.

Select the following menu items to go to the destination display:

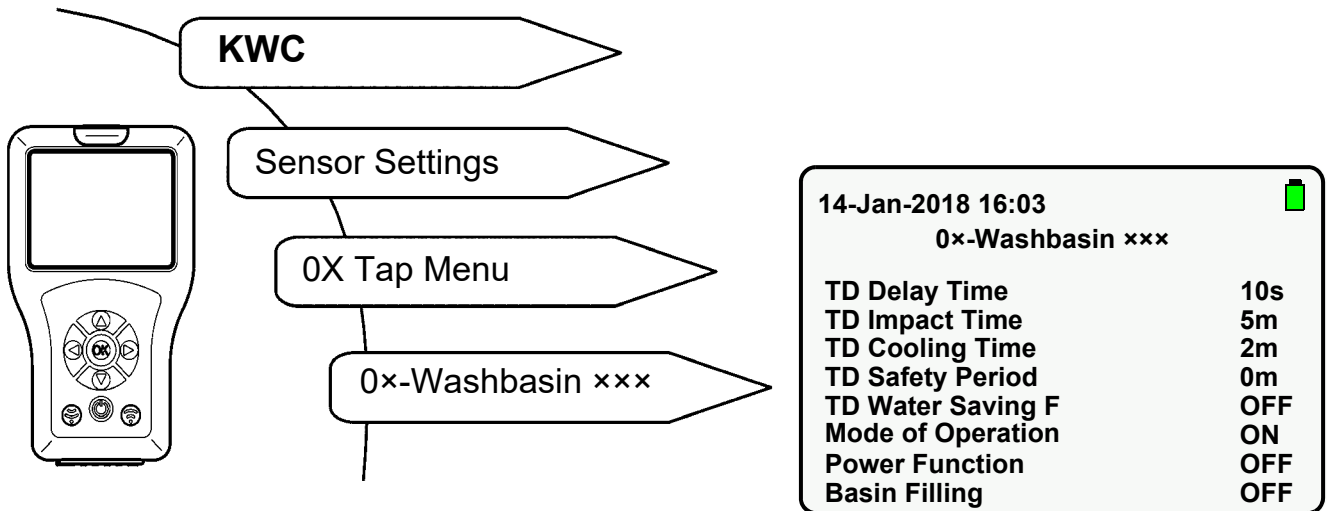

44.1 Select "TD Safety Period" with " ▲▼ " buttons.

44.2 Press the "OK" button.

44.3 Set "TD Safety Period" with " ▲▼ " buttons (0-255 min).

44.4 Confirm with "OK" button.

44.5 Press the  button.

- The parameter change is sent to the tap.

45. Setting TD Water Saving Function

When the water saving function is activated, the water is flushed out intermittently during the application phase.

Select the following menu items to go to the destination display:

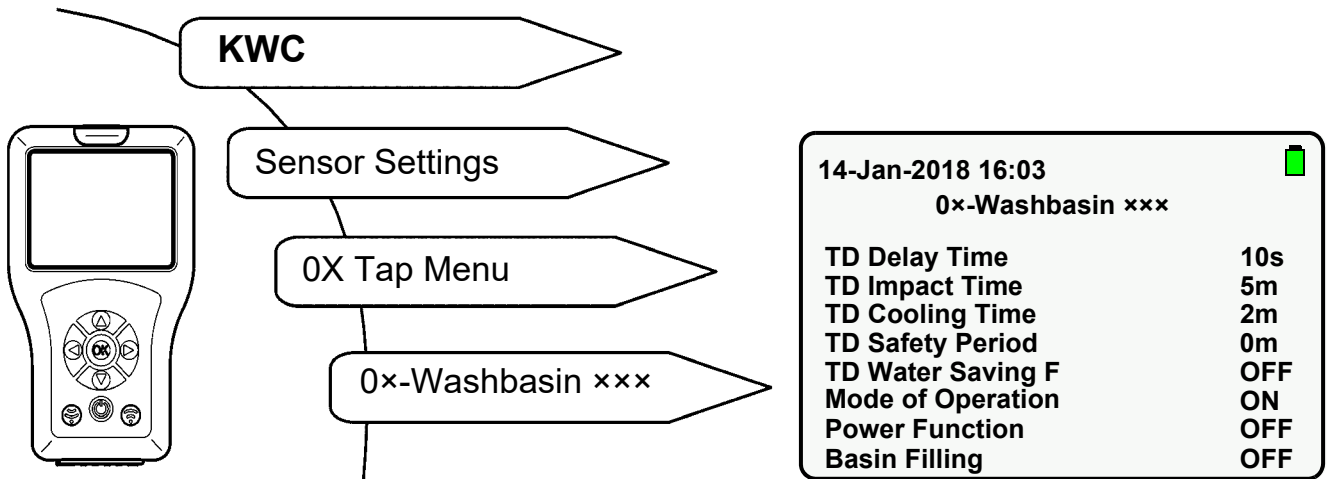

45.1 Select “TD Water Saving F” with “ ▲▼ ” buttons.

45.2 Press the “OK” button.

45.3 Set “TD Water Saving F” to “ON” or “OFF” with “ ▲▼ ” buttons.

45.4 Confirm with “OK” button.

45.5 Press the  button.

- The parameter change is sent to the tap.

46. Start Thermal Disinfection

Thermal Disinfection is a possible treatment measure for bacterial contamination in the water pipe system.

Select the following menu items to go to the destination display:

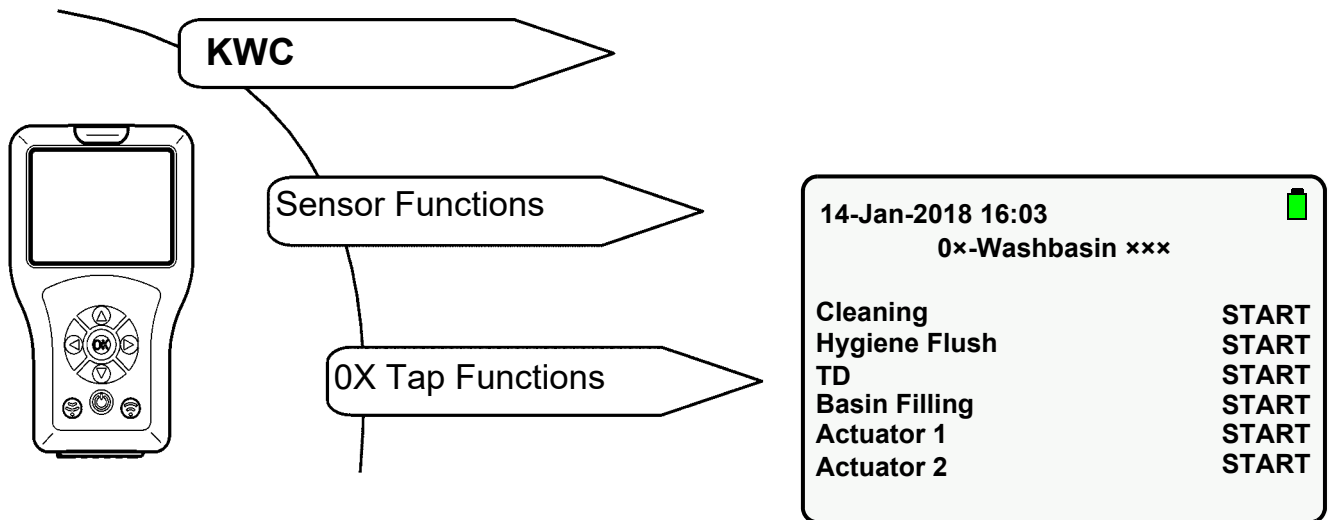

46.1 Select “TD” with “ ▲▼ ” buttons.

46.2 Press the “OK” button.

46.3 Set “TD” to “START” with “ ▲▼ ” buttons.

46.4 Press the  button.

- The tap flashes orange at 2-second intervals during the entire thermal disinfection.

 Only the selected action is executed.

 Thermal Disinfection can be ended ahead of time.

46.5 Select “TD” with “ ▲▼ ” buttons.

46.6 Press the “OK” button.

46.7 Set “TD” to “STOP” with “ ▲▼ ” buttons.

46.8 Press the  button.

- Thermal Disinfection is ended.

Thermal Disinfection Cycle

- Start Thermal Disinfection
- Start delay
The solenoid valve does not open until after the pre-set start delay.
Hot water flows 10 s after start of the thermal disinfection at the earliest.
- Impact time
Hot water flows for 2 min.
After 2 min, the water flows intermittently for the rest of the pre-set time (application phase).
- Safety window
The water in the circulation line will be cooled to the pre-set temperature during this period.
- Cooling phase
The remaining hot water is flushed out of the tap.

47. Activating Statistics

When the Statistics function is activated, the tap stores Statistical Data. Statistical Data is stored for a 24 h interval after application of the operating voltage. Statistical Data is overwritten after 31 days.

Select the following menu items to go to the destination display:

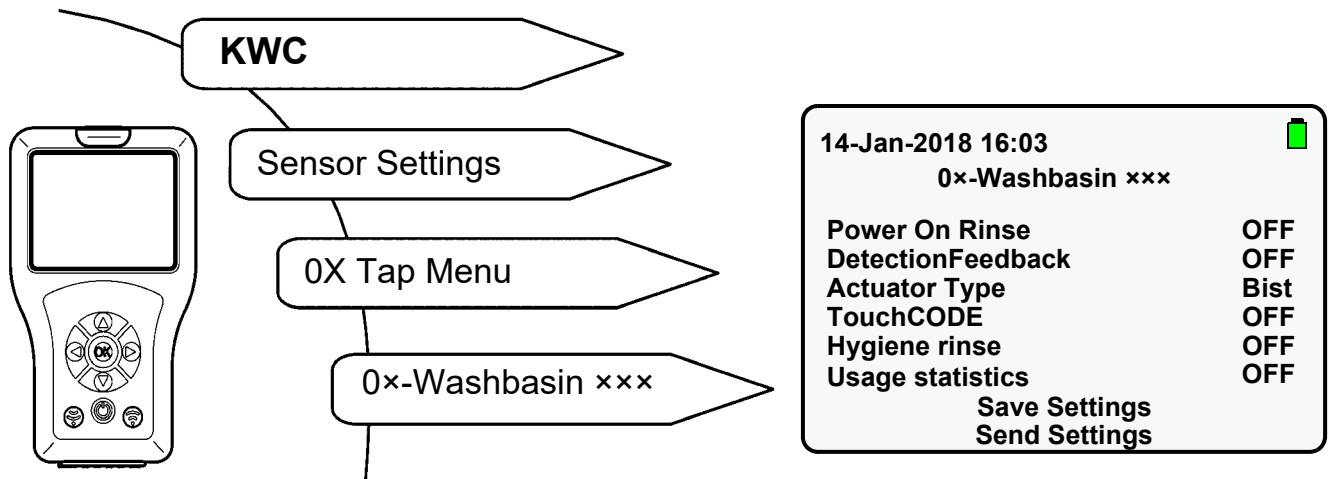

- 47.1 Select "Statistics" with " ▲▼ " buttons.
- 47.2 Press the "OK" button.
- 47.3 Set "Statistics" to "ON" with " ▲▼ " buttons.
- 47.4 Confirm with "OK" button.
- 47.5 Press the  button.
 - The parameter change is sent to the tap.

48. Statistics Readout and Display

Statistical Data can only be read out and displayed if the Statistics function was activated beforehand (siehe [Kapitel 47.](#)).

Select the following menu items to go to the destination display:

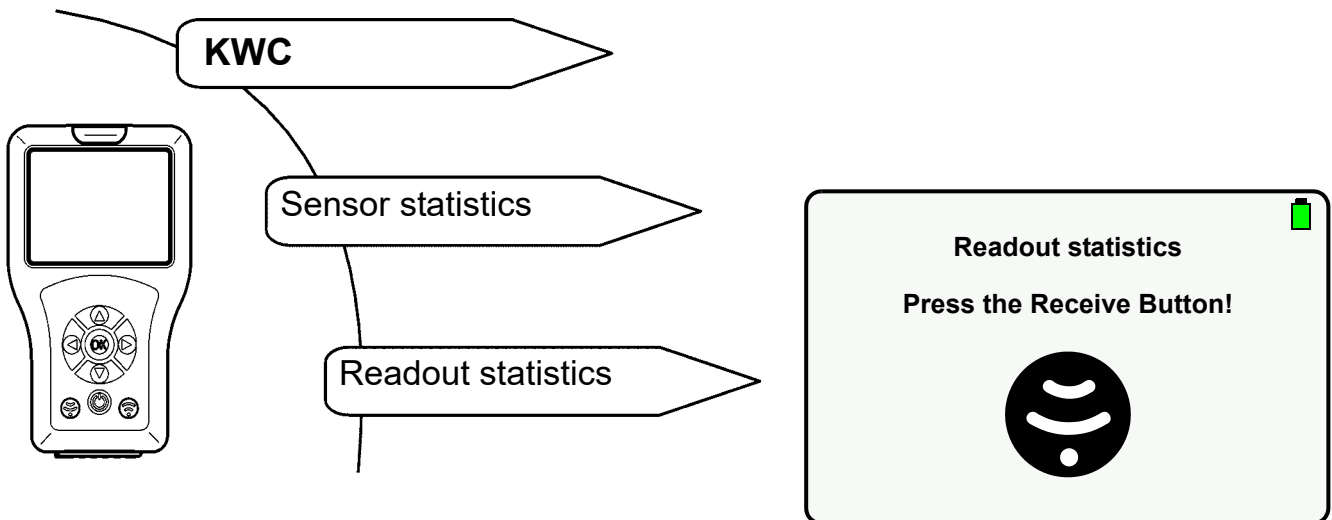

48.1 Select the statistics file with the "OK" button.

- The following display appears:

The screenshot shows the 'Usage Statistics' screen with the following data:

14-Jan-2018 16:03	
Usage Statistics	
Ser. no.	00700:10/08/17
Art. No.	000000000
Last TD	N/A
TD done	No
Last Hyg	02-02-2018 10:03
Act Count	241
Usage Statistics	

Explanation:

- "Last TD" indicates the last thermal disinfection up to a maximum of 10 days with retrospective effect. N/A is indicated in the case of more than 10 days.
- "TD done" indicates whether the last thermal disinfection was carried out without interruption.
- "Last Hyg" indicates the last hygiene purge up to a maximum of 10 days with retrospective effect. N/A is indicated in the case of more than 10 days.
- "Act Count" indicates how often the tap was triggered.

48.2 Navigate downwards with the “ ▲▼ ” buttons, in order to display the number of times the tap was triggered over the last 31 days with retrospective effect.

- The following display appears:

14-Jan-2018 16:03	
Usage Statistics	
Usage	Statistics
02-02-2018:	0
01-02-2018:	0
31-01-2018:	0
30-01-2018:	0
29-01-2018:	0
28-01-2018:	0
27-01-2018:	0

49. Display statistics

Select the following menu items to go to the destination display:

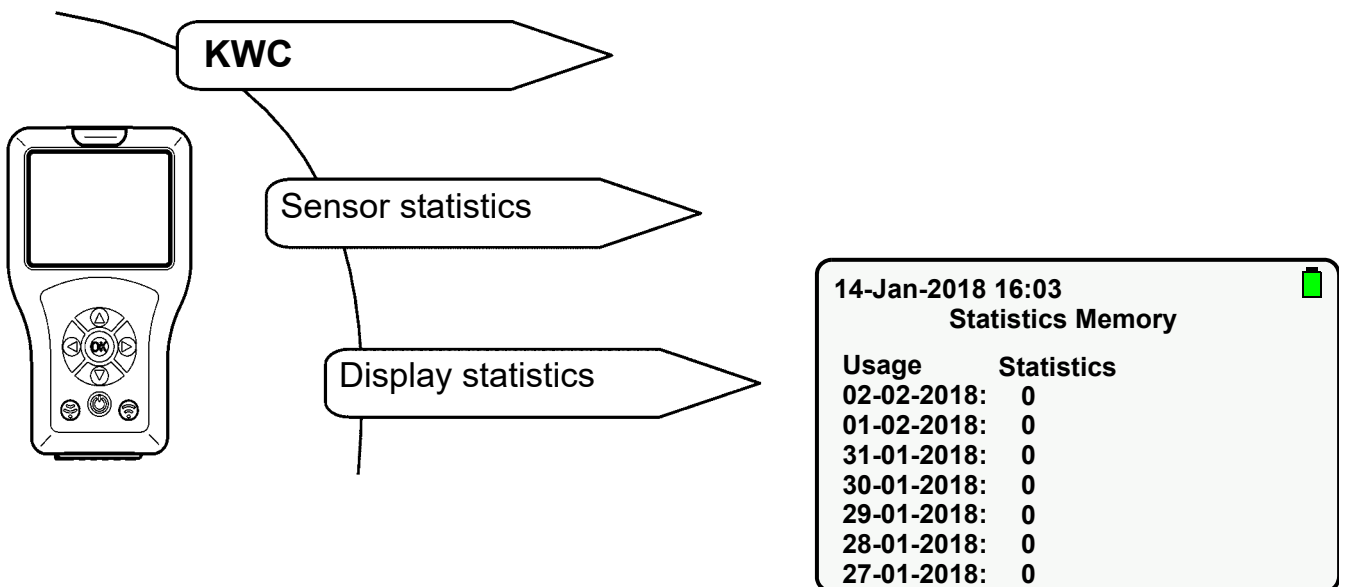

49.1 Navigate downwards with the “ ▲▼ ” buttons to display the desired statistics file.

49.2 Select the statistics file with the “OK” button to display the desired statistical data.

50. Storing Statistics

Select the following menu items to go to the destination display:

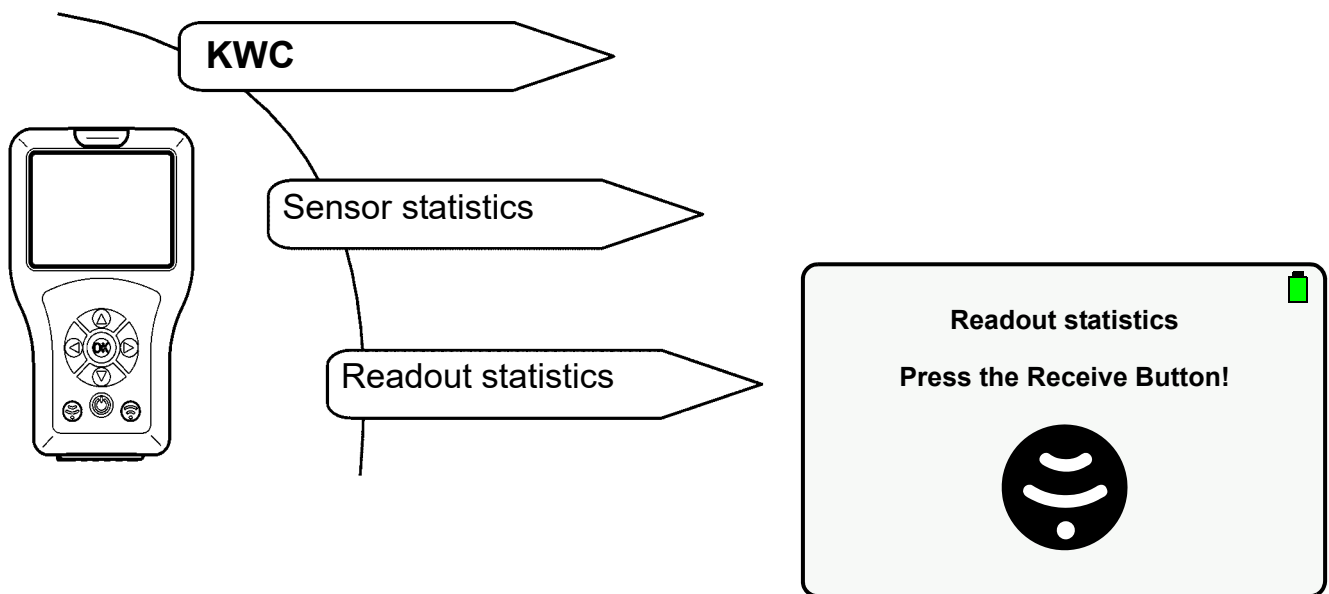

- The current statistical data is displayed.

50.1 Navigate downwards with the “ ▲▼ ” buttons.

50.2 Mark “Save Statistics”.

50.3 Confirm with “OK” button.

- The statistical data is stored.
- A csv file is generated

Important!

The statistical data can be read out in the USB Mass Storage Mode and stored on a PC (siehe [Kapitel 13](#)).

Australia

PR Kitchen and
Water Systems Pty Ltd
Dandenong South VIC 3175
Phone +61 3 9700 9100

Austria

KWC Austria GmbH
6971 Hard, Austria
Phone +43 5574 6735 0

**Belgium, Netherlands &
Luxembourg**

KWC Aquarotter GmbH
9320 Aalst; Belgium
Phone +31 (0) 492 728 224

Czech Republic

KWC Aquarotter GmbH
14974 Ludwigsfelde, Germany
Phone +49 3378 818 309

France

KWC Austria GmbH
6971 Hard, Austria
Phone +33 800 909 216

Germany

KWC Aquarotter GmbH
14974 Ludwigsfelde
Phone +49 3378 818 0

Italy

KWC Austria GmbH
6971 Hard, Austria
Numero Verde +39 800 789 233

Middle East

KWC ME LLC Ras Al Khaimah,
United Arab Emirates
Phone +971 7 2034 700

Poland

KWC Aquarotter GmbH
14974 Ludwigsfelde, Germany
Phone +48 58 35 19 700

Spain

KWC Austria GmbH
6971 Hard, Austria
Phone +43 5574 6735 211

Switzerland & Liechtenstein

KWC Group AG
5726 Unterkulm, Switzerland
Phone +41 62 768 69 00

Turkey

KWC ME LLC Ras Al Khaimah,
United Arab Emirates
Phone +971 7 2034 700

United Kingdom

KWC DVS Ltd - Northern Office
Barlborough S43 4PZ
Phone +44 1246 450 255

KWC DVS Ltd - Southern Office
Paignton TQ4 7TW
Phone +44 1803 529 021

EAST EUROPE

Bosnia Herzegovina
Bulgaria | Croatia
Hungary | Latvia
Lithuania | Romania
Russia | Serbia | Slovakia
Slovenia | Ukraine

KWC Aquarotter GmbH
14974 Ludwigsfelde, Germany
Phone +49 3378 818 261

SCANDINAVIA & ESTONIA

Finland | Sweden | Norway
Denmark | Estonia

KWC Nordics Oy
76850 Naarajärvi, Finland
Phone +358 15 34 111

OTHER COUNTRIES

KWC Austria GmbH
6971 Hard, Austria
Phone +43 5574 6735 0

