

KWC F5E-Therm

Electronic thermostatic in-wall mixer for separate power supply

Modell-Linie: F5E | F5ET1013

Taps | Electronic taps

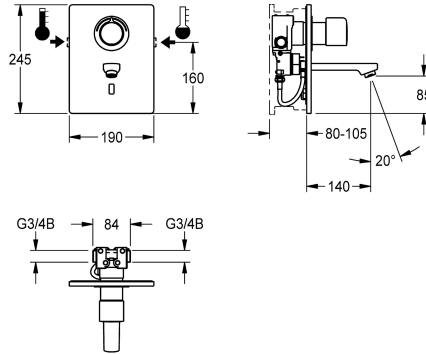

KWC-No.

2030038682

2030038681

Projection 140 mm

2030038683

Projection 260 mm

spout projection

200 mm

140 mm

260 mm

F5E-Therm thermostatic mixer DN 15 as finished installation kit for in-wall installation in basic installation kit, for sanitary facilities. Opto-electronically controlled, for connection to hot water and cold water. Function block with integrated solenoid valve cartridge, thermostat and device for optional bypass solenoid valve cartridge, for program-controlled thermal disinfection. Thermostat with metal handle with adjustable and turn-proof temperature stop and option for manual thermal disinfection. Visible parts made of high-polished chromium-plated brass. Holding frame with profile seal, stainless steel cover plate 190 x 245 mm with covered screw fixing including

sensor with control electronics, rosette, backflow preventer and strainers. Spout with laminar jet controller with integrated flow regulator 6.0 l/min. Projection 140 mm, depth adjustability 25 mm. Activated water hygiene flushing 24 hours after last activation, safety switch-off with continuous reflection and saving of statistical data. With option for parameterization and communication via optional, bidirectional remote control. Separate power supply via power supply unit 6.75 V / 12 V DC or AQUA 3000 open system accessories.

Technical Data

with backflow preventer

Built-in fitting model

calculation flow rate cold wat

calculation flow rate hot water

compatible A3000 open

Cover plate height

Cover plate width

default automatic hygiene flus

depressurised

with filter

functional principle

hygiene flushing

diameter nominal

inlet size

Locking mechanism

material casing

material fitting

minimum flow pressure

type of mixing

yes

Finishing section

0.07 l/s

0.07 l/s

yes

245 mm

190 mm

24h after the last activity

no

yes

electronic self-closing

yes

DN 15

G 3/4 B

Top section, non-ceramic

stainless steel

brass-lock

1 bar

with thermostat



KWC F5E-Therm

Electronic thermostatic in-wall mixer for separate power supply

Modell-Linie: F5E | F5ET1013

Taps | Electronic taps

Parameterization	remote control
Pop-up waste set	no
power supply connection	6,75 / 12 VDC / A3000 open
position of power connection	from top
power consumption	1,5 Voltampere
Type of power supply	Transformer
protective system IP	IP59K
with rosettes/cover plate	yes
protective shutdown	yes
sound insulation	no
Spout	fixed
spout projection	140 mm
surface finish casing	satin finished
surface finish fitting	chromed
surface treatment fitting	polished
temperature limit	yes
thermal disinfection	yes
with transformer/power supply	no
type of mounting	in-wall installation with box
type of operation	sensor operation
type of sensor	opto-electronic sensor
type of tap	in-wall tap
Volume flow rate bypass PWH	0.05 l/s
volume flow rate at 3 bar	0.1 l/s
water connection	threaded connection (external)
Accent colour	chrome-look (glossy)
Basic colour	stainless steel-look

Mandatory Accessories



R5 System box for in-wall mixers

2030028992
F5BX1001

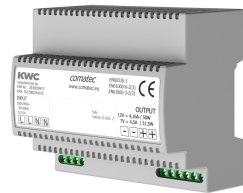

Power supply unit

2030039477
ACEX9001

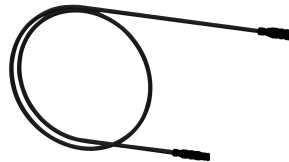

Extension cable 5 m

2030043814
ACEX9010



In-wall power supply

2030039825
ACEX9003

Optional Accessories

KWC F5E-Therm

Electronic thermostatic in-wall mixer for separate power supply

Modell-Linie: F5E | F5ET1013

Taps | Electronic taps



Bidirectional remote control for electronic fittings F3 and F5

2030036654
ACEX9005



2-button remote control for fittings F3 and F5

2030036849
ACEX9004

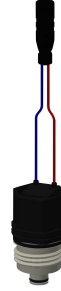

Solenoid valve cartridge

2030045522
ACXX9002

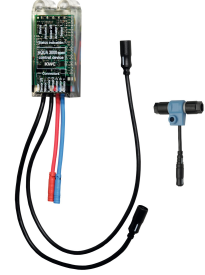

Electronic module for wash basin taps F5

2030041915
ACET1002



Theft-proof housing for aerator

2000104778
ZTAPS0005

Spare Parts



Cover

2030031443
ESHOW0059



Temperature handle

2030047082
ASXT9003

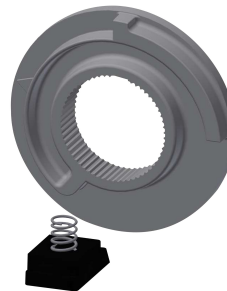

Temperature stop

2030003296
EAQLT0003

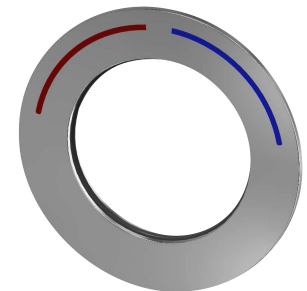

Rosette

2030047081
ASXT9002

KWC F5E-Therm

Electronic thermostatic in-wall mixer for separate power supply

Modell-Linie: F5E | F5ET1013

Taps | Electronic taps

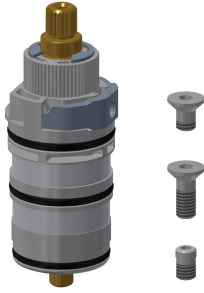

Thermocouple

2030003300
EAQLT0004

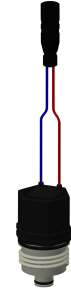

Solenoid valve cartridge

2030045522
ACXX9002



Backflow preventer DN 6

2030045816
ASXX9002

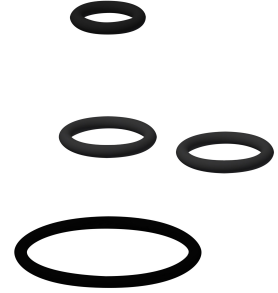

Spare part set

2030045818
ASLM2005

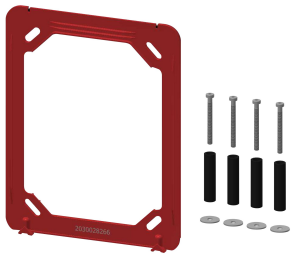

Holding frame

2030045472
ASXX9004

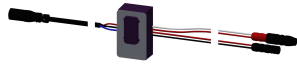

Sensor, ID 01/00004

2030048520
ASET1002

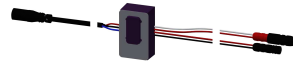

Sensor, ID 01/00005

2030050158
ASET1006

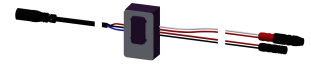

Sensor, ID 01/00006

2030050159
ASET1007



Hose

2030048523
ASET1003



Outlet, 130 mm

2030048530
ASEX1014



Outlet, 190 mm

2030048532
ASEX1015



Outlet, 250 mm

2030048536
ASEX1016

KWC F5E-Therm

Electronic thermostatic in-wall mixer for separate power supply

Modell-Linie: F5E | F5ET1013

Taps | Electronic taps



Laminar jet regulator

2030012352
ETAPS0037



Stainless steel care set

2000109019
ZWSPL0024



Cleaning product CHROMOL

2000105091
ZWSPL0023