

## KWC F5E-Therm

Electronic thermostatic in-wall mixer for separate power supply

Modell-Linie: F5E | F5ET1014

Taps | Electronic taps

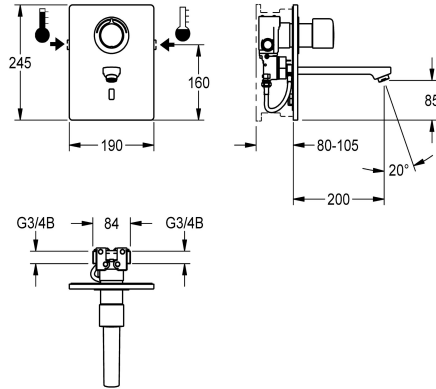

### KWC-No.

**2030038682**

**2030038681**

Projection 140 mm

**2030038683**

Projection 260 mm

### spout projection

200 mm

140 mm

260 mm

F5E-Therm thermostatic mixer DN 15 as finished installation kit for in-wall installation in basic installation kit, for sanitary facilities. Opto-electronically controlled, for connection to hot water and cold water. Function block with integrated solenoid valve cartridge, thermostat and device for optional bypass solenoid valve cartridge, for program-controlled thermal disinfection. Thermostat with metal handle with adjustable and turn-proof temperature stop and option for manual thermal disinfection. Visible parts made of high-polished chromium-plated brass. Holding frame with profile seal, stainless steel cover plate 190 x 245 mm with covered screw fixing including

sensor with control electronics, rosette, backflow preventer and strainers. Spout with laminar jet controller with integrated flow regulator 6.0 l/min. Projection 200 mm, depth adjustability 25 mm. Activated water hygiene flushing 24 hours after last activation, safety switch-off with continuous reflection and saving of statistical data. With option for parameterization and communication via optional, bidirectional remote control. Separate power supply via power supply unit 6.75 V / 12 V DC or AQUA 3000 open system accessories.

### Technical Data

with backflow preventer

Built-in fitting model

calculation flow rate cold wat

calculation flow rate hot water

compatible A3000 open

Cover plate height

Cover plate width

default automatic hygiene flus

depressurised

with filter

functional principle

hygiene flushing

diameter nominal

inlet size

Locking mechanism

material casing

material fitting

minimum flow pressure

type of mixing

yes

Finishing section

0.07 l/s

0.07 l/s

yes

245 mm

190 mm

24h after the last activity

no

yes

electronic self-closing

yes

DN 15

G 3/4 B

Top section, non-ceramic

stainless steel

brass-lock

1 bar

with thermostat

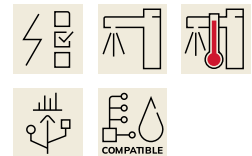

## KWC F5E-Therm

Electronic thermostatic in-wall mixer for separate power supply

**Modell-Linie: F5E | F5ET1014**

Taps | Electronic taps

Parameterization	remote control
Pop-up waste set	no
power supply connection	6,75 / 12 VDC / A3000 open
position of power connection	from top
power consumption	1,5 Voltampere
Type of power supply	Transformer
protective system IP	IP59K
with rosettes/cover plate	yes
protective shutdown	yes
sound insulation	no
Spout	fixed
spout projection	200 mm
surface finish casing	satin finished
surface finish fitting	chromed
surface treatment fitting	polished
temperature limit	yes
thermal disinfection	yes
with transformer/power supply	no
type of mounting	in-wall installation with box
type of operation	sensor operation
type of sensor	opto-electronic sensor
type of tap	in-wall tap
Volume flow rate bypass PWH	0.05 l/s
volume flow rate at 3 bar	0.1 l/s
water connection	threaded connection (external)
Accent colour	chrome-look (glossy)
Basic colour	stainless steel-look

### Mandatory Accessories



**R5 System box for in-wall mixers**

**2030028992**  
F5BX1001

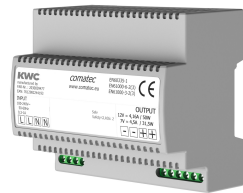

**Power supply unit**

**2030039477**  
ACEX9001

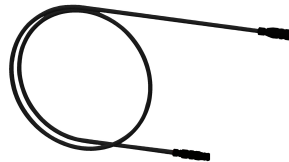

**Extension cable 5 m**

**2030043814**  
ACEX9010



**In-wall power supply**

**2030039825**  
ACEX9003

### Optional Accessories

## KWC F5E-Therm

Electronic thermostatic in-wall mixer for separate power supply

Modell-Linie: F5E | F5ET1014

Taps | Electronic taps



**Bidirectional remote control for electronic fittings F3 and F5**

**2030036654**  
ACEX9005



**2-button remote control for fittings F3 and F5**

**2030036849**  
ACEX9004

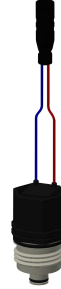

**Solenoid valve cartridge**

**2030045522**  
ACXX9002

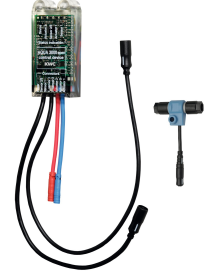

**Electronic module for wash basin taps F5**

**2030041916**  
ACET1003



**Theft-proof housing for aerator**

**2000104778**  
ZTAPS0005

### Spare Parts



**Cover**

**2030031443**  
ESHOW0059



**Temperature handle**

**2030047082**  
ASXT9003

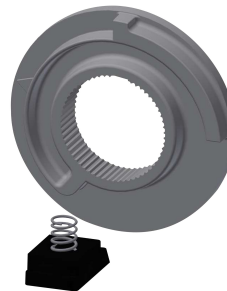

**Temperature stop**

**2030003296**  
EAQLT0003

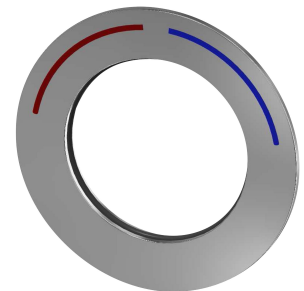

**Rosette**

**2030047081**  
ASXT9002

## KWC F5E-Therm

Electronic thermostatic in-wall mixer for separate power supply

Modell-Linie: F5E | F5ET1014

Taps | Electronic taps



**Thermocouple**

**2030003300**  
EAQLT0004

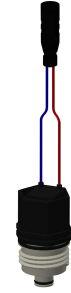

**Solenoid valve cartridge**

**2030045522**  
ACXX9002



**Backflow preventer DN 6**

**2030045816**  
ASXX9002

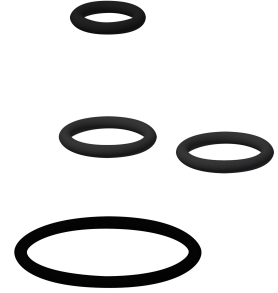

**Spare part set**

**2030045818**  
ASLM2005

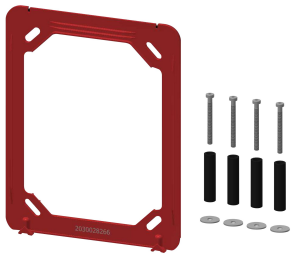

**Holding frame**

**2030045472**  
ASXX9004

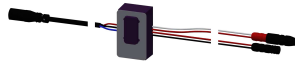

**Sensor, ID 01/00004**

**2030048520**  
ASET1002

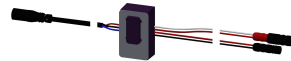

**Sensor, ID 01/00005**

**2030050158**  
ASET1006

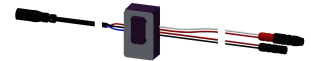

**Sensor, ID 01/00006**

**2030050159**  
ASET1007



**Hose**

**2030048523**  
ASET1003



**Outlet, 130 mm**

**2030048530**  
ASEX1014



**Outlet, 190 mm**

**2030048532**  
ASEX1015



**Outlet, 250 mm**

**2030048536**  
ASEX1016

## KWC F5E-Therm

Electronic thermostatic in-wall mixer for separate power supply

Modell-Linie: F5E | F5ET1014

Taps | Electronic taps



**Laminar jet regulator**

**2030012352**  
ETAPS0037



**Stainless steel care set**

**2000109019**  
ZWSPL0024



**Cleaning product CHROMOL**

**2000105091**  
ZWSPL0023