

## KWC F5E-Mix

Electronic pillar mixer with in-wall power supply

Modell-Linie: F5E | F5EM1009

Taps | Electronic taps

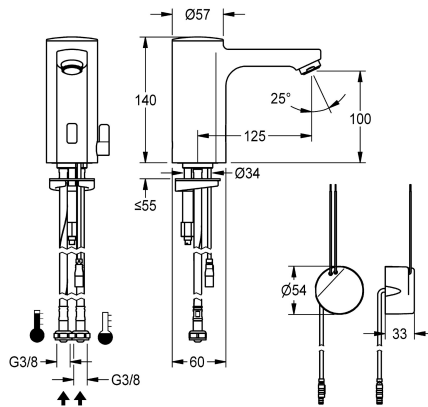

**KWC-No.**

**2030035329**

**2030039432**

with flow regulator 3.0 l/min

**volume flow rate at 3 bar**

0.08 l/s

0.05 l/s

F5E-Mix pillar mixer DN 15 for sanitary facilities, opto-electronically controlled. For connection to hot and cold water via hoses with integrated backflow preventer and strainers. Control electronics, solenoid valve cartridge and sensor in all-metal housing, high-polished chromium-plated brass. Temperature lever with adjustable, turn-proof temperature stop as well as conversion set

for concealed mixing device. Aerator with integrated flow regulator 3.0 l/min. Activated water hygiene flushing 24 hours after last activation, safety switch-off with continuous reflection and saving of statistical data. With option for parameterization and communication via optional, bidirectional remote control. With in-wall power supply 100 - 240 V AC.

**Technical Data**

with backflow preventer
calculation flow rate cold wat
calculation flow rate hot wate
compatible A3000 open
default automatic hygiene flus
depressurised
with filter
functional principle
hygiene flushing
diameter nominal
inlet size
Locking mechanism
material fitting
minimum flow pressure
type of mixing
Parameterization
Pop-up waste set
power supply connection
position of power connection
power consumption
Type of power supply
protective system IP
with rosettes/cover plate

yes
0.07 l/s
0.07 l/s
no
24h after the last activity
no
yes
electronic self-closing
yes
DN 15
G 3/8
Top section, non-ceramic
brass-look
1 bar
yes
remote control
no
100 - 240 V AC
from bottom
1.5 Voltampere
Transformer
IP59K
no



## KWC F5E-Mix

Electronic pillar mixer with in-wall power supply

Modell-Linie: F5E | F5EM1009

Taps | Electronic taps

protective shutdown	yes
sound insulation	no
Spout	fixed
spout projection	125 mm
surface finish fitting	chromed
surface treatment fitting	polished
temperature limit	yes
thermal disinfection	no
with transformer/power supply	yes
type of mounting	tap hole
type of operation	sensor operation
type of sensor	opto-electronic sensor
type of tap	pillar tap
volume flow rate at 3 bar	0.05 l/s
water connection	hose (gland nut)
Accent colour	none
Basic colour	chrome-look (glossy)

### Optional Accessories



**Bidirectional remote control for electronic fittings F3 and F5**

**2030036654**  
ACEX9005



**2-button remote control for fittings F3 and F5**

**2030036849**  
ACEX9004



**Socket**

**2030040334**  
ACEX1001

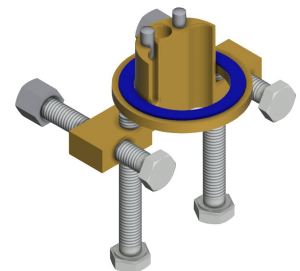

**Anti-twist protection for F5S**

**2030035383**  
ACXX1001

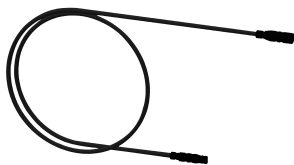

**Extension cable 5 m**

**2030043814**  
ACEX9010



**PURETHERM under-table thermostat**

**2030012758**  
PURE0031

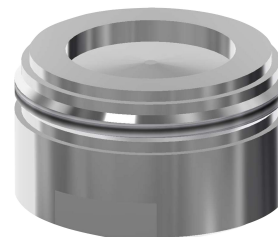

**Aerator 1.8 l/min**

**2030041442**  
ACXX1005



**Theft-proof housing for aerator**

**2000104778**  
ZTAPS0005

## KWC F5E-Mix Electronic pillar mixer with in-wall power supply

Modell-Linie: F5E | F5EM1009  
Taps | Electronic taps

### Spare Parts



**3.0 l/min. aerator**

**2030041424**  
ASXX1008



**Cap**

**2030041558**  
ASEX1007

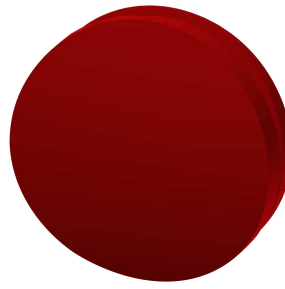

**Plug red**

**2030041951**  
ASEX1009

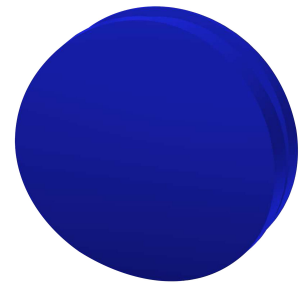

**Plug blue**

**2030041952**  
ASEX1010

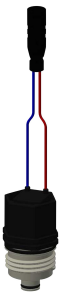

**Solenoid valve cartridge**

**2030045522**  
ACXX9002



**Temperature selection lever**

**2030041431**  
ASEM1001



**Hose**

**2030041320**  
ASXM1001

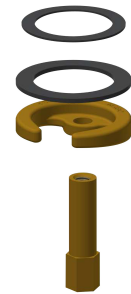

**Quick-action fastener**

**2030043596**  
ASEX1013



**Water way**

**2030041949**  
ASEX1008

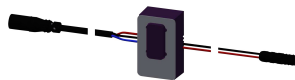

**Sensor, ID 01/00004**

**2030041458**  
ASEX1005



**In-wall power supply**

**2030039825**  
ACEX9003