

KWC F5E

Electronic pillar tap with in-wall power supply

Modell-Linie: F5E | F5EV1007
Taps | Electronic taps

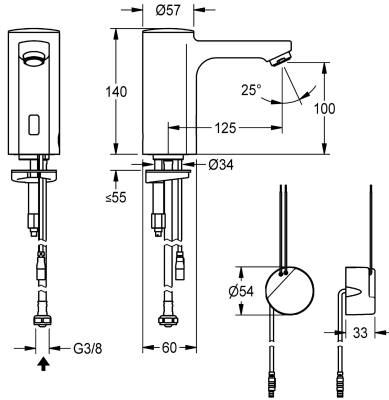

KWC-No.

2030035331

2030039437

with flow regulator 3.0 l/min

volume flow rate at 3 bar

0.08 l/s

0.05 l/s

F5E pillar tap DN 15 for sanitary facilities, opto-electronically controlled. For connection to pre-mixed hot or cold water via hose and strainer. Control electronics, solenoid valve cartridge and sensor in all-metal housing, high-polished chromium-plated brass. Aerator with integrated flow regulator 3.0 l/min. Activated water hygiene

flushing 24 hours after last activation, safety switch-off with continuous reflection and saving of statistical data. With option for parameterization and communication via optional, bidirectional remote control. With in-wall power supply 100 - 240 V AC.

Technical Data

with backflow preventer

no

calculation flow rate cold wat

0.1 l/s

compatible A3000 open

no

default automatic hygiene flus

24h after the last activity

depressurised

no

with filter

yes

functional principle

electronic self-closing

hygiene flushing

yes

diameter nominal

DN 15

inlet size

G 3/8

Locking mechanism

Top section, non-ceramic

material fitting

brass

minimum flow pressure

1 bar

type of mixing

no

Parameterization

remote control

Pop-up waste set

no

power supply connection

100 - 240 V AC

position of power connection

from bottom

power consumption

1.5 Voltampere

Type of power supply

Transformer

protective system IP

IP59K

with rosettes/cover plate

no

protective shutdown

yes

sound insulation

no



KWC F5E

Electronic pillar tap with in-wall power supply

Modell-Linie: F5E | F5EV1007

Taps | Electronic taps

Spout	fixed
spout projection	125 mm
surface finish fitting	chromed
surface treatment fitting	polished
temperature limit	no
thermal disinfection	no
with transformer/power supply	yes
type of mounting	tap hole
type of operation	sensor operation
type of sensor	opto-electronic sensor
type of tap	pillar tap
volume flow rate at 3 bar	0.05 l/s
water connection	hose (gland nut)
Accent colour	none
Basic colour	chrome-look (glossy)

Optional Accessories



Bidirectional remote control for electronic fittings F3 and F5

2030036654
ACEX9005



2-button remote control for fittings F3 and F5

2030036849
ACEX9004



Socket

2030040334
ACEX1001

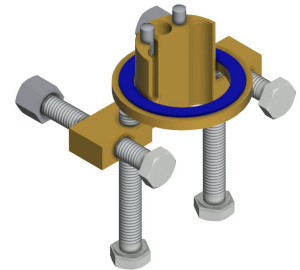

Anti-twist protection for F5S

2030035383
ACXX1001

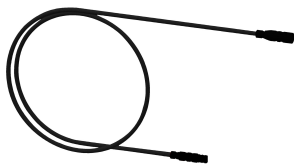

Extension cable 5 m

2030043814
ACEX9010



PURETHERM under-table thermostat

2030012758
PURE0031

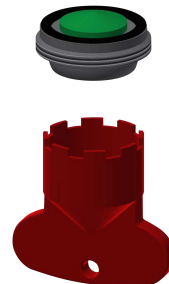

Aerator 5.0 l/min

2030041011
ASXX1004



5.0 l/min aerator, angle-adjustable

2030041326
ACXX1002

KWC F5E

Electronic pillar tap with in-wall power supply

Modell-Linie: F5E | F5EV1007

Taps | Electronic taps

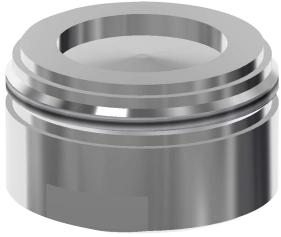

Aerator 1.8 l/min

2030041442
ACXX1005



Theft-proof housing for aerator

2000104778
ZTAPS0005

Spare Parts



3.0 l/min. aerator

2030041424
ASXX1008



Cap

2030041558
ASEX1007

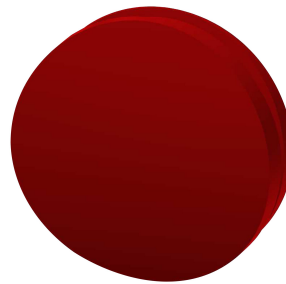

Plug red

2030041951
ASEX1009

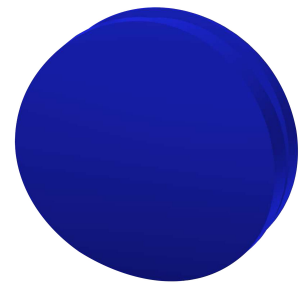

Plug blue

2030041952
ASEX1010

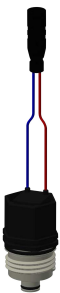

Solenoid valve cartridge

2030003033
EAQFU0001



Hose

2030041311
ASXX1005



Quick-action fastener

2030043596
ASEX1013



Water way

2030041949
ASEX1008

KWC F5E

Electronic pillar tap with in-wall power supply

Modell-Linie: F5E | F5EV1007

Taps | Electronic taps

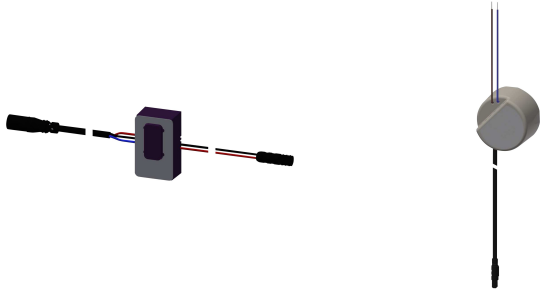

Sensor, ID 01/00004

2030041458
ASEX1005

In-wall power supply

2030039825
ACEX9003