

KWC

F3S self-closing in-wall valve

Modell-Linie: F3S | F3SV2005
Showers | Self closing showers

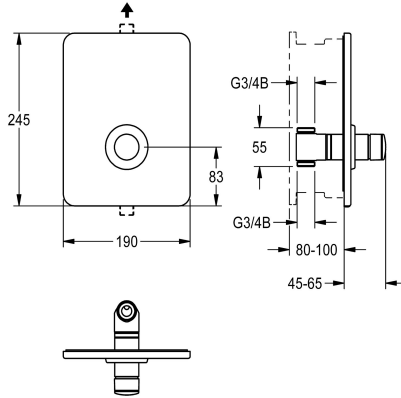

KWC-No.

2030040072

F3S self-closing straight-way valve DN 15 as finished installation kit for installation in basic installation kit, for shower facilities. Self-closing functional part, hydraulically controlled, piston-free design, self-closing, stepless adjustment of flow duration. For connection to pre-mixed hot water or cold water. Housing including changeable

valve seat, visible parts, high-polished chromium-plated brass. Holding frame including profile seal, stainless steel cover plate 190 x 245 mm with covered screw fixing and rosette. Depth adjustability 20 mm.

Technical Data

additional connections	no
with backflow preventer	no
Built-in fitting model	Finishing section
calculation flow rate cold wat	0.15 l/s
circulation	no
connection with pay water disp	not possible
Cover plate height	245 mm
Cover plate width	190 mm
with filter	yes
adjustable flow time	yes
functional principle	hydraulic self-closing
for hand shower	no
hygiene flushing	no
diameter nominal	DN 15
inlet size	G 3/4 B
Locking mechanism	Top section, non-ceramic
material casing	stainless steel
material fitting	brass
maximum flow time	35 Seconds
minimum flow pressure	1 bar
minimum flow time	5 Seconds
type of mixing	no
with rosettes/cover plate	yes
protective shutdown	no
shower pipe draining	no

KWC

F3S self-closing in-wall valve

Modell-Linie: **F3S** | **F3SV2005**

Showers | Self closing showers

sound insulation	no
surface finish casing	satin finished
surface finish fitting	chromed
surface treatment fitting	polished
temperature limit	no
thermal disinfection	no
with transformer/power supply	no
type of mounting	in-wall installation with box
type of operation	manual operation
type of shower	in-wall fitting
volume flow rate at 3 bar	0.2 l/s
water connection	threaded connection (external)
position of water connection	from bottom
Accent colour	chrome-look (glossy)
Basic colour	stainless steel

Mandatory Accessories



R3 system box for in-wall valves

2030040069
F3BV2001

Optional Accessories

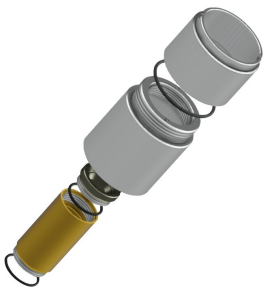

Extension set

2000101451
AQRM900

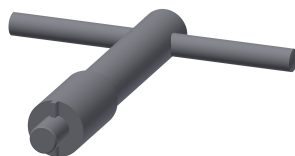

Valve seat key

2000101454
AQRM967

Spare Parts

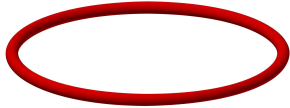

O-Ring, red

2030042961
ASSV2002

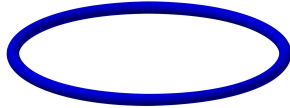

O-Ring, blue

2030042962
ASSV2003

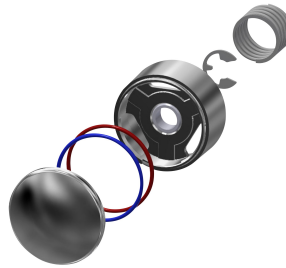

Push cap

2030042960
ASSV2001



Functional part

2000104352
ESHOW0001

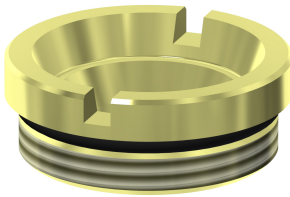

Valve seat DN 15

2000104790
ESHOW0040

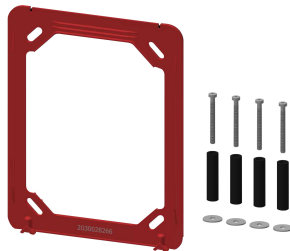

Holding frame

2030045472
ASXX9004



Cover plate stainless steel

2030049685
ASSV2004



Stainless steel care set

2000109019
ZWSP0024



Cleaning product CHROMOL

2000105091
ZWSP0023



Hexagonal socket wrench

2000106127
ZFIT0003