

KWC AQUA3000OPEN Modulo elettronico EM5 per docce

Modell-Linie: AQUA3000OPEN | ACET2001

Aqua3000 open - sistema di gestione dell'acqua | Accessori per sistema di gestione dell'acqua

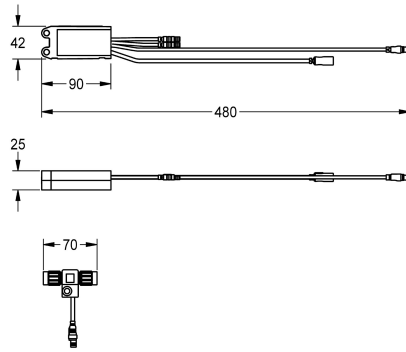

KWC-No.

2030041918

Modulo elettronico e connettore elettrico a T per l'integrazione in AQUA 3000 open

Modulo elettronico EM5 con ID 07040 e connettore elettrico a T. Per l'integrazione nel sistema di gestione dell'acqua AQUA 3000 open

24 V DC.

Dati tecnici

Capacità	1
Quantità UOM	Pezzi
teamNumber	0

1
Pezzi
0



Accessori necessari



Controller ECC2

2000108123
ZA3OP0011

Controller ECC2

2030016282
ZA3OP0022

Cavo di sistema

2000100801
ZAQUA077

Cavo di sistema

2000100852
ZAQUA078

KWC AQUA3000OPEN Modulo elettronico EM5 per docce

Modell-Linie: AQUA3000OPEN | ACET2001

Aqua3000 open - sistema di gestione dell'acqua | Accessori per sistema di gestione dell'acqua

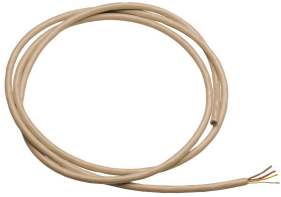

Cavo di sistema

2000104272
ZAQUA011

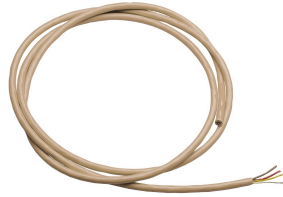

Cavo di sistema

2000104274
ZAQUA012

Accessori opzionali

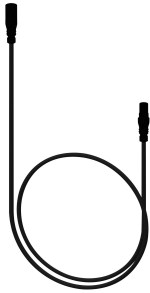

Cavo di prolunga a sensore

2030041919
ACEX9006

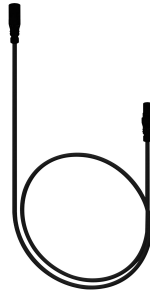

Cavo di prolunga a sensore

2030041920
ACEX9007

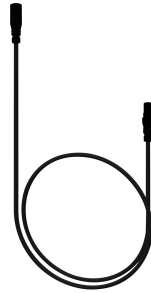

Cavo di prolunga (3 m)

2030056669
ACEX9013



Cavo di prolunga

2000101055
ZAQUA073

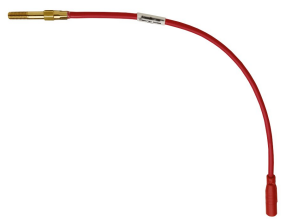

Sensore della temperatura avvitabile

2000100972
ZAQUA017



Sensore della temperatura a incasso

2000100974
ZAQUA019



Sensore della temperatura ad incasso

2000100973
ZAQUA018



Sensore della temperatura di contatto

2000100975
ZAQUA020

KWC AQUA3000OPEN Modulo elettronico EM5 per docce

Modell-Linie: AQUA3000OPEN | ACET2001

Aqua3000 open - sistema di gestione dell'acqua | Accessori per sistema di gestione dell'acqua

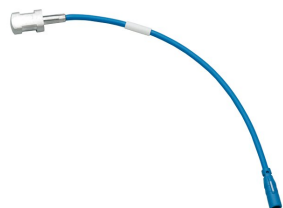

Sensore della temperatura di contatto

2000100976
ZAQUA021
