

KWC

Outlet, 190 mm

Modell-Linie: F5 | ASEX1015
Spare parts | Spare parts taps

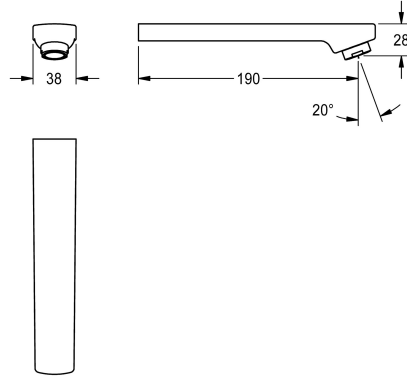

KWC-No.

2030048532

Outlet for F3E and F5E in-wall mounted fittings, with laminar jet controller with integrated flow regulator 6.0 l/min, projection 190

mm.

Technical Data

spout projection

190 mm

type of spout

wall outlet

volume flow rate at 3 bar

0.1 l/s