

## KWC F5S Mix stainless steel shower panel

Modell-Linie: F5S | F5SM2020  
Showers | Self closing showers

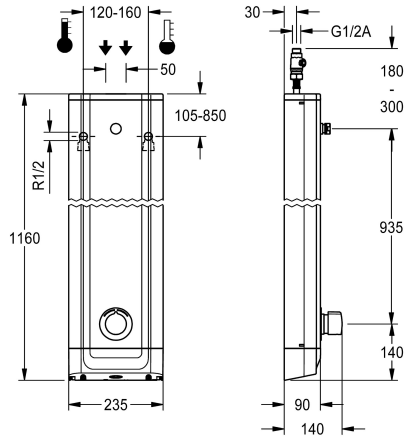

### KWC-No.

**2030054248**

**2030056581**

with automatic shower pipe draining

### shower pipe draining

no

yes

F5S Mix shower panel made of stainless steel for wall mounting with DN 15 self-closing single control mixer and connecting nozzles for the shower head. FRAMIC self-closing mixing cartridge, hydraulically controlled, low maintenance and stagnation free, with ceramic disc technology, self-closing, flow pressure independent due to the medium-independent design. Stepless adjustment of flow duration. With adjustable, turn-proof temperature stop. For connection to hot water and cold water. All-metal construction, visible parts high-polished or chrome-plated. Connecting nozzles for

the required additional DN 15 KWC shower head with pre-fitted flow regulator 9.0 l/min. Housing made of stainless steel with raised function surface and plastic cover caps. Connecting hoses with lockable water volume control with backflow preventer and strainer.

Dimensions of housing 235 x 1160 x 90 mm (W x H x D)

Shower head to be ordered separately.

### Technical Data

additional connections

no

with backflow preventer

yes

circulation

no

compatible A3000 open

no

connection with pay water disp

not possible

with filter

yes

adjustable flow time

yes

functional principle

hydraulic self-closing

for hand shower

no

hygiene flushing

no

diameter nominal

DN 15

inlet size

G 1/2 A

Locking mechanism

Top section, ceramic

material casing

stainless steel

material code casing

1.4301 Chrome Nickel steel V2A

material fitting

brass

maximum flow time

35 Seconds

minimum flow pressure

1.5 bar

minimum flow time

5 Seconds

type of mixing

yes

overall depth

90 mm



## KWC

### F5S Mix stainless steel shower panel

Modell-Linie: F5S | F5SM2020  
Showers | Self closing showers

overall height	1,160 mm
overall width	235 mm
with rosettes/cover plate	yes
protective shutdown	no
shower pipe draining	no
Shower head	for separately shower head
with shower set	no
sound insulation	no
surface finish casing	satin finished
surface finish fitting	chromed
surface treatment fitting	polished
temperature limit	yes
thermal disinfection	no
type of mounting	wall mounting
type of operation	manual operation
type of shower	shower panel
volume flow rate at 3 bar	0.15 l/s
water connection	hose (gland nut)
position of water connection	from top / backside
with soap dish	no
Accent colour	chrome-look (glossy)
Basic colour	stainless steel

#### Mandatory Accessories



**AQUAJET-Slimline shower head for KWC shower panels and systems**

**2030054255**  
SHAS0011



**AQUAJET-Comfort shower head for KWC shower panels and systems**

**2030054254**  
SHAC0011



**MÜNCHEN shower head for KWC shower panels and systems**

**2030054793**  
SHMU0011

#### Optional Accessories

## KWC

### F5S Mix stainless steel shower panel

Modell-Linie: F5S | F5SM2020  
Showers | Self closing showers

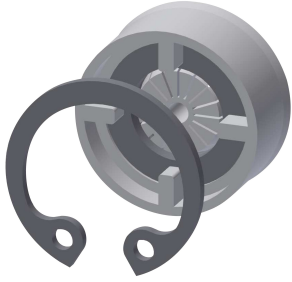

Flow controller 6.0 l/min

**2030027586**  
ESHHE0004

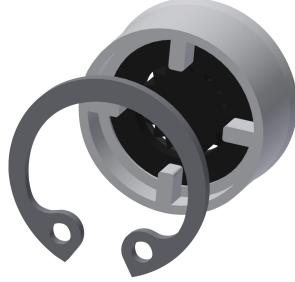

Flow controller 12.0 l/min

**2000104783**  
ESHHE0002

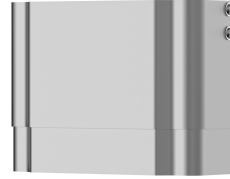

Housing extension for F5 shower panels made of stainless steel

**2030057066**  
ACXX2011

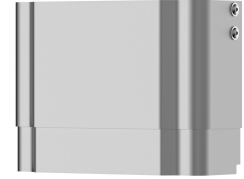

Housing extension for F5 shower panels made of stainless steel

**2030057067**  
ACXX2012

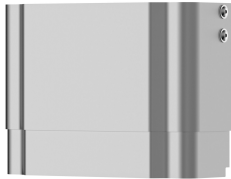

Housing extension for F5 shower panels made of stainless steel

**2030057068**  
ACXX2013

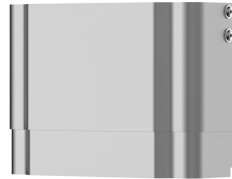

Housing extension for F5 shower panels made of stainless steel

**2030057069**  
ACXX2014

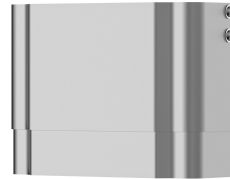

Housing extension for F5 shower panels made of stainless steel

**2030057070**  
ACXX2015

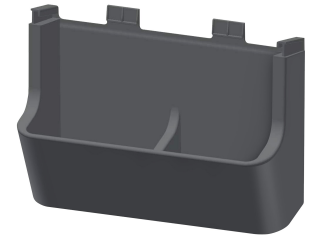

Shower gel dish for F5 shower panels made of stainless steel

**2030057077**  
ACXX2021

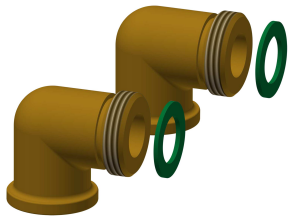

Connection set for shower panel

**2000104916**  
ZSHOW0006



Connection adapter

**2000101441**  
AQRM928

## Spare Parts

## KWC

### F5S Mix stainless steel shower panel

Modell-Linie: F5S | F5SM2020  
Showers | Self closing showers



**Plug chromed**

**2030053006**  
ASSX9004



**Handle push cap**

**2030050753**  
ASSM9004



**Temperature stop**

**2030046189**  
ASSM9002

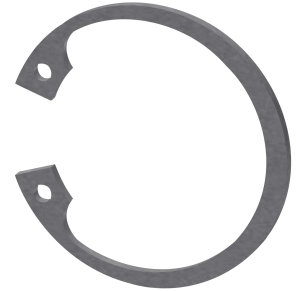

**Safety ring**

**2030048357**  
ASSX9003

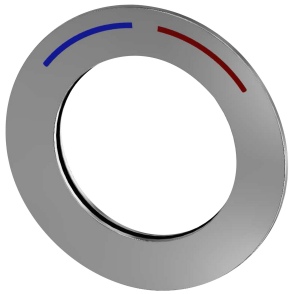

**Rosette**

**2030045510**  
ASXM2003



**FRAMIC self-closing mixing cartridge**

**2030046185**  
ASSM9001

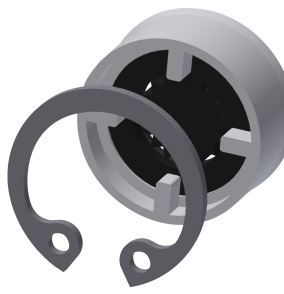

**Flow controller 9.0 l/min**

**2000104782**  
ESHHE0001



**Stainless steel care set**

**2000109019**  
ZWSP0024



**Cleaning product CHROMOL**

**2000105091**  
ZWSP0023