

## KWC F5S-Therm Shower panel made of MIRANIT

Modell-Linie: F5S | F5ST2027  
Showers | Self closing showers

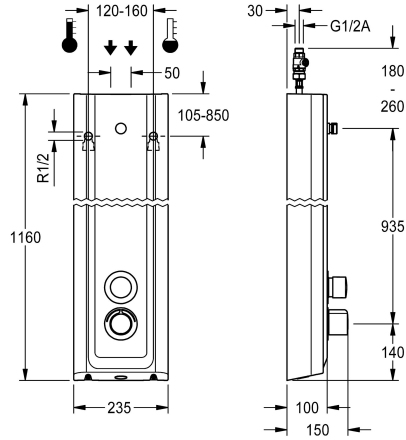

### KWC-No.

**2030056545**

F5S Therm shower panel made of mineral material for wall mounting with DN 15 self-closing thermostatic mixer and connecting nozzles for the shower head. Hydraulically controlled, for connection to hot water and cold water. Shower valve with integrated FRAMIC self-closing cartridge, thermostat and mechanism for an optional water hygiene unit for automatic water hygiene flushing, program-controlled thermal disinfection (additional bypass solenoid-operated flush valve cartridge required) and storage of statistical data. FRAMIC self-closing cartridge, low maintenance and stagnation free, with ceramic disc technology, self-closing, flow pressure independent due to the medium-independent design. Stepless adjustment of flow duration. Thermostat with metal handle, an adjustable and turn-proof

temperature stop and an option for manual thermal disinfection. All-metal construction, visible parts high-polished or chrome-plated. Connecting nozzles for the required additional DN 15 KWC shower head with pre-fitted flow regulator 9.0 l/min. Housing with raised function surface made of MIRANIT resin-bonded mineral material with pore-free smooth surface (temperature-resistant up to 80 °C), Alpine white colour. Connecting hoses with lockable water volume control with backflow preventer and strainer.

Dimensions of housing 235 x 1160 x 100 mm (W x H x D)

Shower head to be ordered separately.

### Technical Data

additional connections
with backflow preventer
circulation
compatible A3000 open
connection with pay water disp
with filter
adjustable flow time
functional principle
for hand shower
hygiene flushing
diameter nominal
inlet size
Locking mechanism
material casing
material code casing
material fitting
maximum flow time
minimum flow pressure
minimum flow time
type of mixing
overall depth

no
yes
no
no
not possible
yes
yes
hydraulic self-closing
no
prepared
DN 15
G 1/2 A
Top section, ceramic
mineral material
Miranit
brass-look
35 Seconds
1.5 bar
5 Seconds
with thermostat
100 mm



## KWC F5S-Therm Shower panel made of MIRANIT

Modell-Linie: F5S | F5ST2027  
Showers | Self closing showers

overall height	1,160 mm
overall width	235 mm
with rosettes/cover plate	yes
protective shutdown	no
shower pipe draining	no
Shower head	for separately shower head
with shower set	no
sound insulation	no
surface finish fitting	chromed
surface treatment fitting	polished
temperature limit	yes
thermal disinfection	yes
type of mounting	wall mounting
type of operation	manual operation
type of shower	shower panel
volume flow rate at 3 bar	0.15 l/s
water connection	hose (gland nut)
position of water connection	from top / backside
Accent colour	chrome-look (glossy)
Basic colour	white

### Mandatory Accessories



**AQUAJET-Slimline shower head for KWC shower panels and systems**

**2030054255**  
SHAS0011



**AQUAJET-Comfort shower head for KWC shower panels and systems**

**2030054254**  
SHAC0011

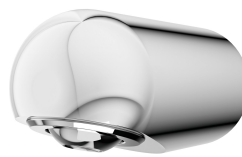

**MÜNCHEN shower head for KWC shower panels and systems**

**2030054793**  
SHMU0011

### Optional Accessories

## KWC F5S-Therm Shower panel made of MIRANIT

Modell-Linie: F5S | F5ST2027  
Showers | Self closing showers



Flow controller 6.0 l/min

**2030027586**  
ESHHE0004



Flow controller 12.0 l/min

**2000104783**  
ESHHE0002

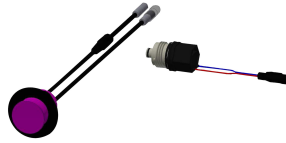

Hygiene unit for F5S Therm shower panel

**2030057064**  
ACST2004



Housing extension for F5 shower panels made of MIRANIT

**2030057071**  
ACXX2016

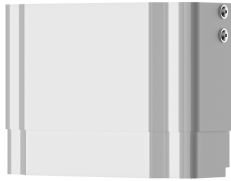

Housing extension for F5 shower panels made of MIRANIT

**2030057072**  
ACXX2017

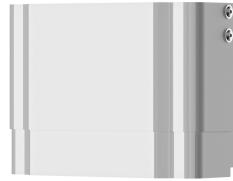

Housing extension for F5 shower panels made of MIRANIT

**2030057073**  
ACXX2018



Housing extension for F5 shower panels made of MIRANIT

**2030057075**  
ACXX2019



Housing extension for F5 shower panels made of MIRANIT

**2030057076**  
ACXX2020

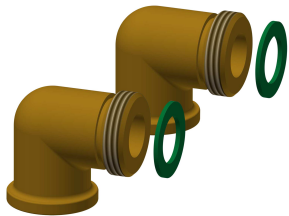

Connection set for shower panel

**2000104916**  
ZSHOW0006



Connection adapter

**2000101441**  
AQRM928

### Spare Parts

## KWC F5S-Therm Shower panel made of MIRANIT

Modell-Linie: F5S | F5ST2027  
Showers | Self closing showers



**Flow controller 9,0 l/min**

**2000104782**  
ESHHE0001



**Cover**

**2030031443**  
ESHOW0059



**Temperature handle**

**2030047082**  
ASXT9003

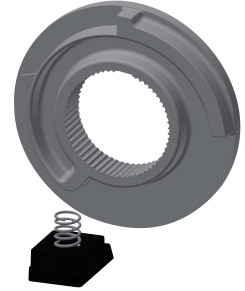

**Temperature stop**

**2030003296**  
EAQLT0003



**Plug chromed**

**2030053006**  
ASSX9004



**Push cap**

**2030049943**  
ASST2001



**Safety ring**

**2030048357**  
ASSX9003

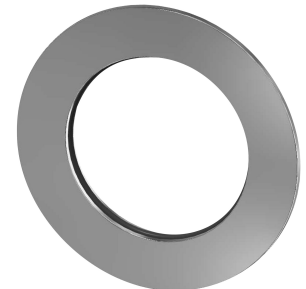

**Rosette**

**2030048765**  
ASET2006



**FRAMIC Self-closing cartridge**

**2030046145**  
ASSX9001