

KWC

Housing extension for F5 shower panels made of stainless steel

Modell-Linie: F5 | ACXX2012

Showers | Complementary parts showers

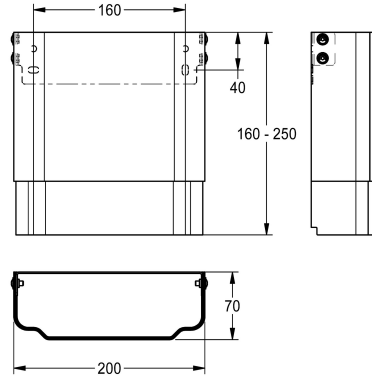

KWC-No.

2030057066

Housing dimensions approx. 200 x 110–170 mm (W x H)

2030057067

Housing dimensions approx. 200 x 160–250 mm (W x H)

2030057068

Housing dimensions approx. 200 x 240–410 mm (W x H)

2030057069

Housing dimensions approx. 200 x 400–660 mm (W x H)

2030057070

Housing dimensions approx. 200 x 650–960 mm (W x H)

Housing extension made of stainless steel, height-adjustable, for F5 shower panels made of stainless steel, to cover wall-mounted pipe installations, includes mounting materials.

Housing dimensions approx. 200 x 160–250 mm (W x H)