

KWC

Housing extension for F5 shower panels made of MIRANIT

Modell-Linie: F5 | ACXX2016

Duschar | Kompletterande delar duschar

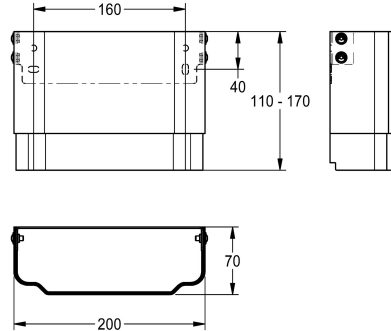

KWC-No.

2030057071

Housing dimensions approx. 200 x 110–170 mm (W x H)

2030057072

Housing dimensions approx. 200 x 160–250 mm (W x H)

2030057073

Housing dimensions approx. 200 x 240–410 mm (W x H)

2030057075

Housing dimensions approx. 200 x 400–660 mm (W x H)

2030057076

Housing dimensions approx. 200 x 650–960 mm (W x H)

Husförlängning av rostfritt stål, pulverbelagt i alpinvit färg, höjdjusterar, för F5-duschpaneler av mineraliska materialet MIRANIT, för beklädnad av ytmonterade rörinstallation, komplett

med monteringsmaterial.

Husmått ca 200 x 110 till 170 mm (B x H)