

## KWC

Housing extension for F5 shower panels made of MIRANIT

Modell-Linie: F5 | ACXX2020

Showers | Complementary parts showers

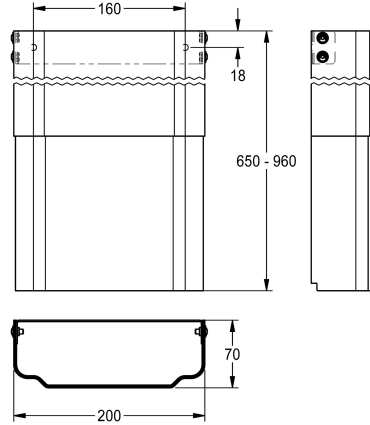

### KWC-No.

---

**2030057071**

Housing dimensions approx. 200 x 110–170 mm (W x H)

---

**2030057072**

Housing dimensions approx. 200 x 160–250 mm (W x H)

---

**2030057073**

Housing dimensions approx. 200 x 240–410 mm (W x H)

---

**2030057075**

Housing dimensions approx. 200 x 400–660 mm (W x H)

---

**2030057076**

Housing dimensions approx. 200 x 650–960 mm (W x H)

---

Housing extension made of stainless steel, powder-coated Alpine white colour, height-adjustable, for F5 shower panels made of MIRANIT mineral material, to cover wall-mounted pipe installations,

includes mounting material.

Housing dimensions approx. 200 x 650–960 mm (W x H)