

## KWC F5L-Therm Shower panel made of MIRANIT

Modell-Linie: F5L | F5LT2024  
Showers | Manual shower

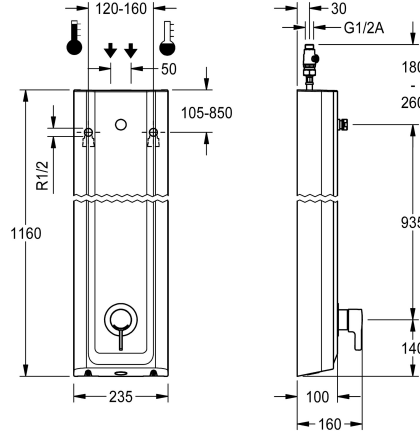

### KWC-No.

2030066543

F5L-Therm shower panel made from mineral material for wall mounting with single-lever thermostat DN 15 and connecting nozzle for shower head. For connection to hot and cold water. Function block with integrated mixing cartridge and pre-assembled hygiene unit including sensor with control electronics to perform automatic water hygiene flushing, program-controlled thermal disinfection (additional bypass solenoid-operated flush valve cartridge necessary) and storage of statistical data. Thermostatically-controlled mixer cartridge with expansion element and active scald protection as well as adjustable and turn-proof temperature stop, and ceramic disc technology. All-metal construction, visible parts high-polished, chrome-plated. Connecting nozzles for separate required DN 15 KWC shower head with pre-fitted flow regulator 9.0 l/min. Housing with raised function surface made of MIRANIT resin-

bonded mineral material with pore-free smooth surface (temperature-resistant up to 80 °C), Alpine white colour. With adjustable and lockable connections with backflow preventer and strainers. Activated hygiene flushing, fixed interval of 24 hours. With option for parameterization and communication via optional, bidirectional remote control. Optional hygiene unit for battery operation with 6 V lithium battery (CR-P2) per fitting or separate power supply via plug-in power supply unit 6.75 V/12 V DC.

Housing dimensions 235 x 1160 x 100 mm (W x H x D)

Shower head and battery compartment including battery or power supply unit with extension cable must be ordered separately.

### Technical Data

additional connections
with backflow preventer
circulation
compatible A3000 open
connection with pay water disp
default automatic hygiene flus
with filter
adjustable flow time
functional principle
for hand shower
hygiene flushing
diameter nominal
inlet size
Locking mechanism
material casing
material code casing
material fitting
minimum flow pressure
type of mixing
overall depth

no
yes
no
no
not possible
fixed interval 24 hours
yes
no
manual
no
yes
DN 15
G 1/2 A
Top section, ceramic
mineral material
Miranit
brass-look
1 bar
with thermostat
100 mm

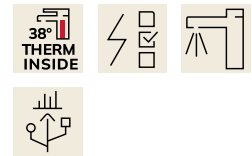

## KWC F5L-Therm Shower panel made of MIRANIT

Modell-Linie: F5L | F5LT2024  
Showers | Manual shower

overall height	1,160 mm
overall width	235 mm
Parameterization	remote control
power supply connection	6,75 / 12 VDC
position of power connection	from top / backside
Type of power supply	Other
protective system IP	IP59K
with rosettes/cover plate	yes
protective shutdown	no
shower pipe draining	no
Shower head	for separately shower head
with shower set	no
sound insulation	no
surface finish fitting	chromed
surface treatment fitting	polished
temperature limit	yes
thermal disinfection	yes
with transformer/power supply	no
type of mounting	wall mounting
type of operation	manual operation
type of sensor	opto-electronic sensor
type of shower	shower panel
volume flow rate at 3 bar	0,15 l/s
water connection	hose (gland nut)
position of water connection	from top / backside
with soap dish	no
Accent colour	chrome-look (glossy)
Basic colour	white

### Mandatory Accessories



**AQUAJET-Slimline shower head for KWC shower panels and systems**

**2030054255**  
SHAS0011



**AQUAJET-Comfort shower head for KWC shower panels and systems**

**2030054254**  
SHAC0011



**MÜNCHEN shower head for KWC shower panels and systems**

**2030054793**  
SHMU0011



**Battery compartment**

**360002063**  
ACEX9023

## KWC F5L-Therm Shower panel made of MIRANIT

Modell-Linie: F5L | F5LT2024  
Showers | Manual shower

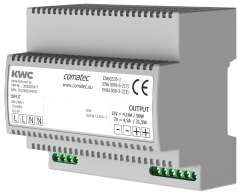

Power supply unit

**2030039477**  
ACEX9001

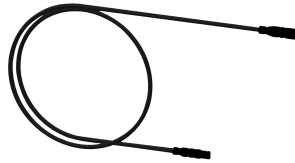

Extension cable 5 m

**2030043814**  
ACEX9010

### Optional Accessories

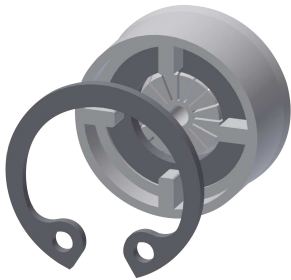

Flow controller 6.0 l/min

**2030027586**  
ESHHE0004

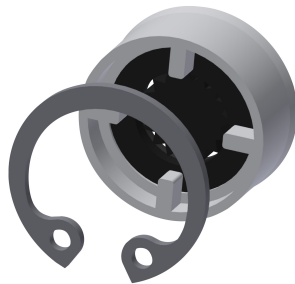

Flow controller 12.0 l/min

**2000104783**  
ESHHE0002



Solenoid valve cartridge

**2030003033**  
EAQFU0001



Housing extension for F5 shower panels made of MIRANIT

**2030057071**  
ACXX2016



Housing extension for F5 shower panels made of MIRANIT

**2030057072**  
ACXX2017



Housing extension for F5 shower panels made of MIRANIT

**2030057073**  
ACXX2018



Housing extension for F5 shower panels made of MIRANIT

**2030057075**  
ACXX2019



Housing extension for F5 shower panels made of MIRANIT

**2030057076**  
ACXX2020

## KWC F5L-Therm Shower panel made of MIRANIT

Modell-Linie: F5L | F5LT2024  
Showers | Manual shower



**2-button remote control for fittings F3 and F5**

**2030036849**  
ACEX9004



**Bidirectional remote control for electrical fittings F3 and F5**

**2030036654**  
ACEX9005

### Spare Parts

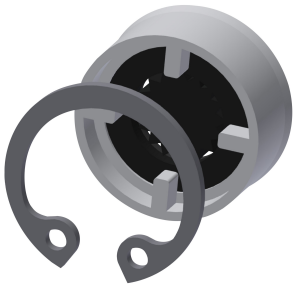

**Flow controller 9,0 l/min**

**2000104782**  
ESHHE0001

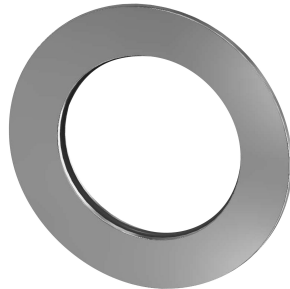

**Rosette**

**2030048765**  
ASET2006



**Solenoid valve cartridge**

**2030003033**  
EAQFU0001