

KWC F5L-Therm Shower panel made of MIRANIT with hand shower fitting

Modell-Linie: F5L | F5LT2025
Showers | Manual shower

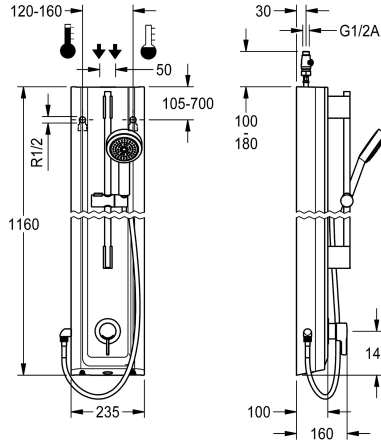

KWC-No.

2030066544

F5L-Therm shower panel made from mineral material for wall mounting with single-lever thermostat DN 15 and hand shower fitting kit. For connection to hot and cold water. Function block with integrated mixing cartridge and pre-assembled hygiene unit including sensor with control electronics to perform automatic water hygiene flushing, program-controlled thermal disinfection (additional bypass solenoid-operated flush valve cartridge necessary) and storage of statistical data. Thermostatically-controlled mixer cartridge with expansion element and active scald protection as well as adjustable and turn-proof temperature stop, and ceramic disc technology. All-metal construction, visible parts high-polished, chrome-plated. Pre-fitted chrome-plated brass shower rail with height-adjustable hand shower holder and chrome-plated plastic hand shower, shower head with rain jet, diameter 110 mm, shower hose 900 mm. Housing with raised function

surface made of MIRANIT resin-bonded mineral material with pore-free smooth surface (temperature-resistant up to 80 °C), Alpine white colour. With adjustable and lockable connections with backflow preventer and strainers. Activated hygiene flushing, fixed interval of 24 hours. With option for parameterization and communication via optional, bidirectional remote control. Optional hygiene unit for battery operation with 6 V lithium battery (CR-P2) per fitting or separate power supply via plug-in power supply unit 6.75 V/12 V DC.

Housing dimensions 235 x 1160 x 100 mm (W x H x D)

Battery compartment including battery or power supply unit with extension cable must be ordered separately.

Technical Data

| |
|---------------------------------|
| additional connections |
| with backflow preventer |
| circulation |
| compatible A3000 open |
| connection with pay water disp |
| default automatic hygiene flush |
| with filter |
| adjustable flow time |
| functional principle |
| for hand shower |
| hygiene flushing |
| diameter nominal |
| inlet size |
| Locking mechanism |
| material casing |
| material code casing |
| material fitting |
| minimum flow pressure |
| type of mixing |
| overall depth |

| |
|-------------------------|
| no |
| yes |
| no |
| no |
| not possible |
| fixed interval 24 hours |
| yes |
| no |
| manual |
| yes |
| yes |
| DN 15 |
| G 1/2 A |
| Top section, ceramic |
| mineral material |
| Miranit |
| brass-look |
| 1 bar |
| with thermostat |
| 100 mm |

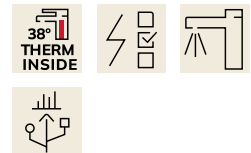

KWC F5L-Therm

Shower panel made of MIRANIT with hand shower fitting

Modell-Linie: F5L | F5LT2025

Showers | Manual shower

| | |
|-------------------------------|------------------------|
| overall height | 1,160 mm |
| overall width | 235 mm |
| Parameterization | remote control |
| power supply connection | 6,75 / 12 VDC |
| Type of power supply | Other |
| protective system IP | IP59K |
| with rosettes/cover plate | yes |
| protective shutdown | no |
| shower pipe draining | no |
| with shower set | yes |
| sound insulation | no |
| surface finish fitting | chromed |
| surface treatment fitting | polished |
| temperature limit | yes |
| thermal disinfection | yes |
| with transformer/power supply | no |
| type of mounting | wall mounting |
| type of operation | manual operation |
| type of sensor | opto-electronic sensor |
| type of shower | shower panel |
| volume flow rate at 3 bar | 0.15 l/s |
| water connection | hose (gland nut) |
| position of water connection | from top / backside |
| with soap dish | no |
| Accent colour | chrome-look (glossy) |
| Basic colour | white |

Mandatory Accessories

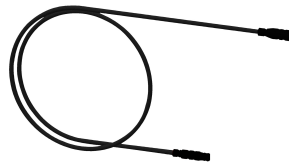

Battery compartment

360002063
ACEX9023

Power supply unit

2030039477
ACEX9001

Extension cable 5 m

2030043814
ACEX9010

Optional Accessories

KWC F5L-Therm

Shower panel made of MIRANIT with hand shower fitting

Modell-Linie: F5L | F5LT2025

Showers | Manual shower

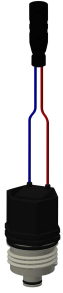

Solenoid valve cartridge

2030003033
EAQFU0001



Housing extension for F5 shower panels made of MIRANIT

2030057071
ACXX2016



Housing extension for F5 shower panels made of MIRANIT

2030057072
ACXX2017



Housing extension for F5 shower panels made of MIRANIT

2030057073
ACXX2018

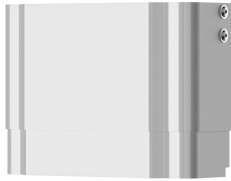

Housing extension for F5 shower panels made of MIRANIT

2030057075
ACXX2019

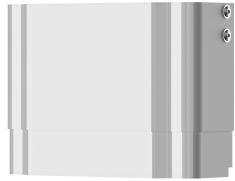

Housing extension for F5 shower panels made of MIRANIT

2030057076
ACXX2020



Bidirectional remote control for electronic fittings F3 and F5

2030036654
ACEX9005



2-button remote control for fittings F3 and F5

2030036849
ACEX9004

Spare Parts



Hand shower

2030051216
ACXX2007

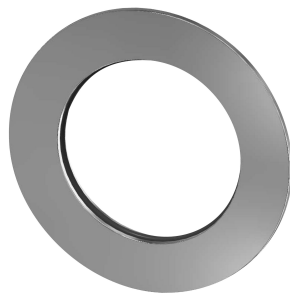

Rosette

2030048765
ASET2006



Solenoid valve cartridge

2030003033
EAQFU0001