

## KWC F5L-Therm

Shower panel made of MIRANIT with shower gel shelf

Modell-Linie: F5L | F5LT2029  
Showers | Manual shower

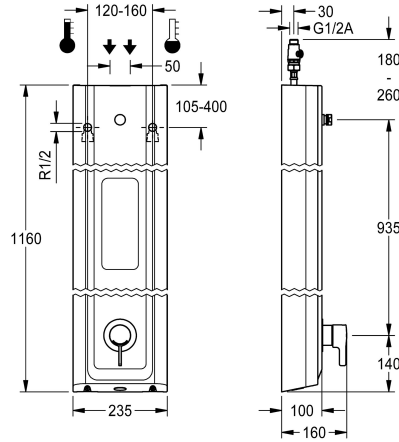

### KWC-No.

**2030066549**

F5L-Therm shower panel made from mineral material for wall mounting with single-lever thermostat DN 15 and connecting nozzle for shower head. For connection to hot and cold water. Function block with integrated mixing cartridge and mechanism for an optional water hygiene unit for automatic water hygiene flushing, program-controlled thermal disinfection (additional bypass solenoid-operated flush valve cartridge necessary) and storage of statistical data. Thermostatically-controlled mixer cartridge with expansion element and active scald protection as well as adjustable and turn-proof temperature stop, and ceramic disc technology. All-metal construction, visible parts high-polished,

chrome-plated. Connecting nozzles for separate required DN 15 KWC shower head with pre-fitted flow regulator 9.0 l/min. Housing with raised function surface and seamless moulded shower gel shelf made of MIRANIT resin-bonded mineral material with pore-free smooth surface (temperature-resistant up to 80 °C), Alpine white colour. With adjustable and lockable connections with backflow preventer and strainers.

Housing dimensions 235 x 1160 x 100 mm (W x H x D)

Shower head must be ordered separately.

### Technical Data

additional connections	no
with backflow preventer	yes
circulation	no
compatible A3000 open	no
connection with pay water disp	not possible
with filter	yes
adjustable flow time	no
functional principle	manual
for hand shower	no
hygiene flushing	prepared
diameter nominal	DN 15
inlet size	G 1/2 A
Locking mechanism	Top section, ceramic
material casing	mineral material
material code casing	Miranit
material fitting	brass-look
minimum flow pressure	1 bar
type of mixing	with thermostat
overall depth	100 mm
overall height	1,160 mm
overall width	235 mm
with rosettes/cover plate	yes

additional connections	no
with backflow preventer	yes
circulation	no
compatible A3000 open	no
connection with pay water disp	not possible
with filter	yes
adjustable flow time	no
functional principle	manual
for hand shower	no
hygiene flushing	prepared
diameter nominal	DN 15
inlet size	G 1/2 A
Locking mechanism	Top section, ceramic
material casing	mineral material
material code casing	Miranit
material fitting	brass-look
minimum flow pressure	1 bar
type of mixing	with thermostat
overall depth	100 mm
overall height	1,160 mm
overall width	235 mm
with rosettes/cover plate	yes



## KWC F5L-Therm

Shower panel made of MIRANIT with shower gel shelf

Modell-Linie: F5L | F5LT2029

Showers | Manual shower

protective shutdown	no
shower pipe draining	no
Shower head	for separately shower head
with shower set	no
sound insulation	no
surface finish fitting	chromed
surface treatment fitting	polished
temperature limit	yes
thermal disinfection	yes
type of mounting	wall mounting
type of operation	manual operation
type of shower	shower panel
volume flow rate at 3 bar	0.15 l/s
water connection	hose (gland nut)
position of water connection	from top / backside
with soap dish	integrated
Accent colour	chrome-look (glossy)
Basic colour	white

### Mandatory Accessories



**AQUAJET-Slimline shower head for KWC shower panels and systems**

**2030054255**  
SHAS0011



**AQUAJET-Comfort shower head for KWC shower panels and systems**

**2030054254**  
SHAC0011



**MÜNCHEN shower head for KWC shower panels and systems**

**2030054793**  
SHMU0011

### Optional Accessories

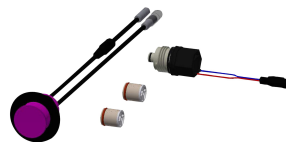
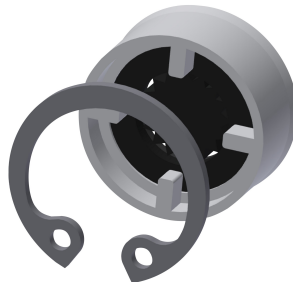
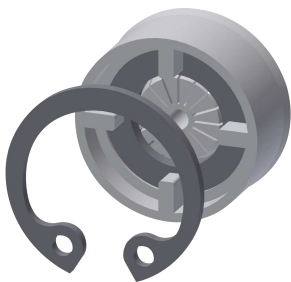

## KWC F5L-Therm

Shower panel made of MIRANIT with shower gel shelf

Modell-Linie: F5L | F5LT2029  
Showers | Manual shower

### Flow controller 6.0 l/min

**2030027586**  
ESHHE0004



### Flow controller 12.0 l/min

**2000104783**  
ESHHE0002



### Hygiene unit for F5L single lever mixer shower panel

**2030057065**  
ACLM2003



### Housing extension for F5 shower panels made of MIRANIT

**2030057071**  
ACXX2016



### Housing extension for F5 shower panels made of MIRANIT

**2030057072**  
ACXX2017

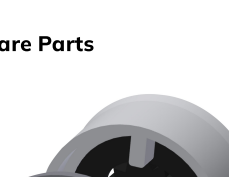

### Housing extension for F5 shower panels made of MIRANIT

**2030057073**  
ACXX2018



### Housing extension for F5 shower panels made of MIRANIT

**2030057075**  
ACXX2019



### Housing extension for F5 shower panels made of MIRANIT

**2030057076**  
ACXX2020



## Spare Parts

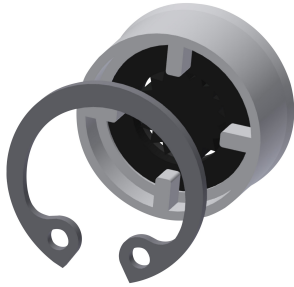

### Flow controller 9.0 l/min

**2000104782**  
ESHHE0001

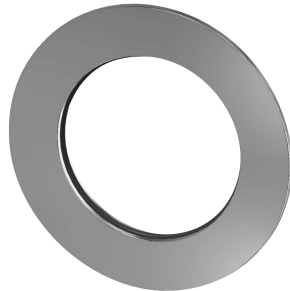

### Rosette

**2030048765**  
ASET2006