

KWC F5E-Therm Electronic thermostatic in-wall mixer

Modell-Linie: F5E | F5ET2031
Showers | Electronic self closing shower

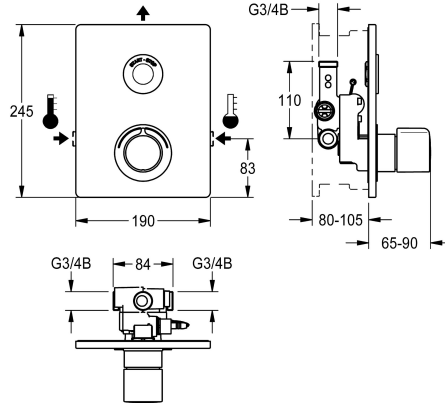

KWC-No.

2030067151

F5E-Therm thermostatic mixer DN 15 as finished installation kit for wall mounting in mounting material, for shower facilities. Electrically controlled, connects to hot water and cold water. Function block with integrated solenoid valve cartridge, thermostat and mechanism for two optional bypass solenoid valve cartridges for separate rinsing of the cold-water line and implementation of program-controlled thermal disinfection as well as for separate sampling of cold or hot water. Thermostat with metal handle with adjustable and turn-proof temperature stop and option for manual thermal disinfection. All-metal construction, visible parts high-polished, chrome-plated. With holding frame and profile seal, stainless-steel cover plate 190 x 245 mm with covered screw fixing including sensor with control

electronics, rosette, backflow preventers and strainers. Depth adjustability 25 mm. Activated hygiene flushing 24 hours after last activation and storage of statistical data. With option for parameterization and communication via optional, bidirectional remote control.

Optionally for battery operation with 6 V lithium battery (CR-P2) per fitting or separate power supply via power supply unit 6.75 V/12 V DC or AQUA 3000 open system accessories.

Battery compartment including battery or power supply unit with extension cable must be ordered separately.

Technical Data

additional connections

no

with backflow preventer

yes

Built-in fitting model

Finishing section

calculation flow rate cold wat

0.15 l/s

calculation flow rate hot water

0.15 l/s

circulation

no

compatible A3000 open

yes

connection with pay water disp

via electronic module

Cover plate height

245 mm

Cover plate width

190 mm

default automatic hygiene flus

24h after the last activity

default flow time

30 Seconds

with filter

yes

adjustable flow time

yes

functional principle

electronic self-closing

for hand shower

no

hygiene flushing

yes

diameter nominal

DN 15

inlet size

G 3/4 B

Locking mechanism

Top section, non-ceramic

material casing

stainless steel

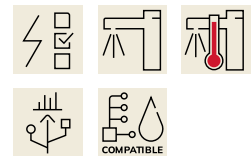

KWC F5E-Therm Electronic thermostatic in-wall mixer

Modell-Linie: F5E | F5ET2031
Showers | Electronic self closing shower

material fitting	brass-look
maximum flow time	255 Seconds
minimum flow pressure	1 bar
minimum flow time	1 Seconds
type of mixing	with thermostat
Parameterization	remote control
power supply connection	6,75 / 12 VDC / A3000 open
position of power connection	from top
power consumption	1.5 Voltampere
Type of power supply	Transformer
with rosettes/cover plate	yes
protective shutdown	yes
shower pipe draining	no
sound insulation	no
surface finish casing	satin finished
surface finish fitting	chromed
surface treatment fitting	polished
temperature limit	yes
thermal disinfection	yes
with transformer/power supply	no
type of mounting	in-wall installation with box
type of operation	sensor operation
type of sensor	opto-electronic sensor
type of shower	in-wall fitting
Volume flow rate bypass PWH	0.05 l/s
volume flow rate at 3 bar	0.23 l/s
water connection	threaded connection (external)
position of water connection	from side
Accent colour	chrome-look (glossy)
Basic colour	stainless steel-look

Mandatory Accessories

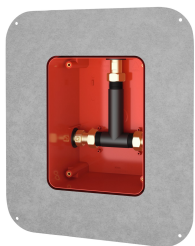

R5 System box for in-wall mixer

2030028990
F5BX2001



Battery compartment

360002063
ACEX9023

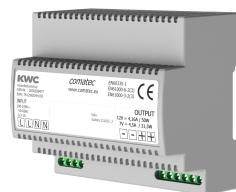

Power supply unit

2030039477
ACEX9001

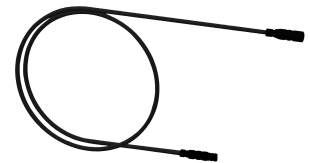

Extension cable 5 m

2030043814
ACEX9010

KWC F5E-Therm Electronic thermostatic in-wall mixer

Modell-Linie: F5E | F5ET2031
Showers | Electronic self closing shower

Optional Accessories



Bidirectional remote control for electronic fittings F3 and F5

2030036654
ACEX9005



2-button remote control for fittings F3 and F5

2030036849
ACEX9004

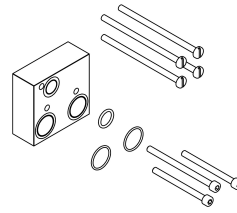

Extension set

2030067889
ACXT9001



Solenoid valve cartridge

2030003033
EAQFU0001

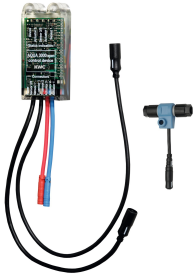

Electronic module EM5 for F5 shower taps

2030041918
ACET2001

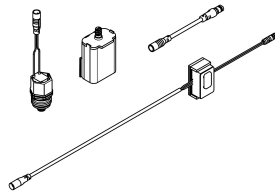

Set for flushing the cold-water line

2030071564
ACXT2005

Spare Parts

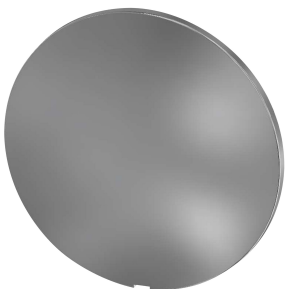

Cover

2030003258
EAQLT0002

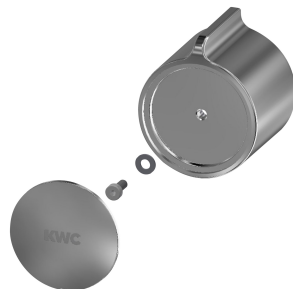

Temperature handle

2030047082
ASXT9003

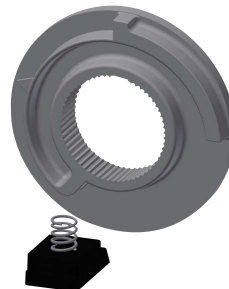

Temperature stop

2030003296
EAQLT0003



Solenoid valve cartridge

2030003033
EAQFU0001

KWC F5E-Therm Electronic thermostatic in-wall mixer

Modell-Linie: F5E | F5ET2031
Showers | Electronic self closing shower

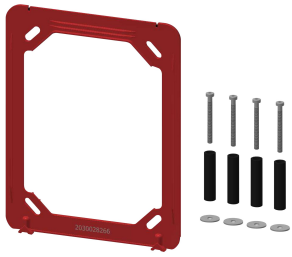

Holding frame

2030045472
ASXX9004



Stainless steel care set

2000109019
ZWSP0024



Cleaning product CHROMOL

2000105091
ZWSP0023