

KWC F5S-Therm self-closing thermostatic in-wall mixer

Modell-Linie: F5S | F5ST2036
Showers | Self closing showers

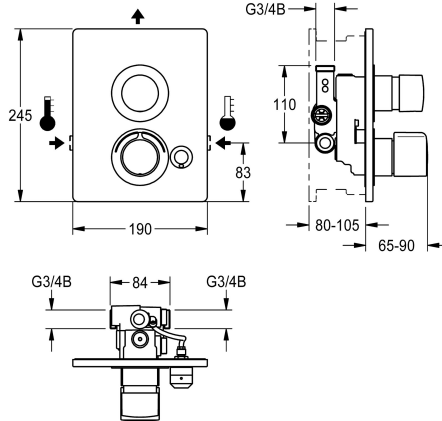

KWC-No.

2030067154

2030067163
With automatic shower pipe emptying

2030067158
Version without option for automatic water hygiene flushing or thermal disinfection

2030067167
with automatic shower pipe draining

shower pipe draining

no

yes

no

yes

thermal disinfection

yes

yes

no

no

F5S-Therm self-closing thermostatic mixer DN 15 as finished installation kit for wall mounting in mounting kit, for shower facilities. Hydraulically controlled, connects to hot water and cold water. Function block with integrated FRAMIC self-closing cartridge, thermostat and mechanism for an optional water hygiene unit for automatic water hygiene flushing, program-controlled thermal disinfection (additional bypass solenoid-operated flush valve cartridge necessary) and storage of statistical data. Additional mechanism for second bypass solenoid valve cartridge for separate rinsing of the cold-water line and separate sampling of cold or hot water. FRAMIC self-closing cartridge, low maintenance

and stagnation free, with ceramic disc technology, self closing, flow pressure independent due to medium-independent design. Continuously adjustable flow duration. Thermostat with metal handle with adjustable and turn-proof temperature stop and option for manual thermal disinfection. All-metal construction, visible parts high-polished, chrome-plated. Holding frame including profile seal, stainless steel cover 190 x 245 mm with covered screw fixing, chrome-plated plastic rosettes, non-return valve and strainers. Depth adjustability 25 mm. Version with automatic shower pipe emptying.

Technical Data

additional connections

no

with backflow preventer

yes

Built-in fitting model

Finishing section

calculation flow rate cold wat

0.15 l/s

calculation flow rate hot water

0.15 l/s

circulation

no

compatible A3000 open

no

connection with pay water disp

not possible

with filter

yes

adjustable flow time

yes

functional principle

hydraulic self-closing

for hand shower

no

hygiene flushing

prepared

diameter nominal

DN 15

inlet size

G 3/4 B

Locking mechanism

Top section, ceramic

material casing

stainless steel

KWC

F5S-Therm self-closing thermostatic in-wall mixer

Modell-Linie: F5S | F5ST2036

Showers | Self closing showers

material fitting	brass-look
maximum flow time	35 Seconds
minimum flow pressure	1 bar
minimum flow time	5 Seconds
type of mixing	with thermostat
with rosettes/cover plate	yes
protective shutdown	no
shower pipe draining	yes
sound insulation	no
surface finish casing	satin finished
surface finish fitting	chromed
surface treatment fitting	polished
temperature limit	yes
thermal disinfection	yes
type of mounting	in-wall installation with box
type of operation	manual operation
type of shower	in-wall fitting
volume flow rate at 3 bar	0.2 l/s
water connection	threaded connection (external)
position of water connection	from side
Accent colour	chrome-look (glossy)
Basic colour	stainless steel-look

Mandatory Accessories

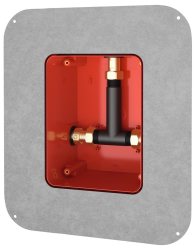

R5 System box for in-wall mixer

2030028990

F5BX2001

Optional Accessories

KWC

F5S-Therm self-closing thermostatic in-wall mixer

Modell-Linie: F5S | F5ST2036
Showers | Self closing showers

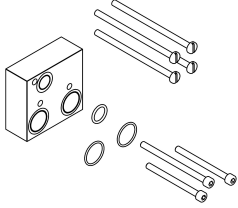

Extension set

2030067889
ACXT9001

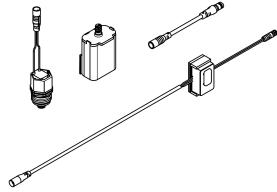

Set for flushing the cold-water line

2030071564
ACXT2005

Spare Parts



Cover

2030003258
EAQLT0002



Temperature handle

2030047082
ASXT9003

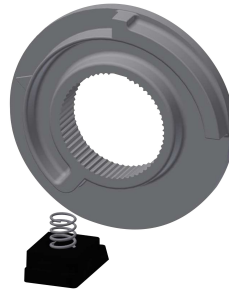

Temperature stop

2030003296
EAQLT0003



Plug chromed

2030053006
ASSX9004



Push cap

2030049943
ASST2001



Safety ring

2030048357
ASSX9003

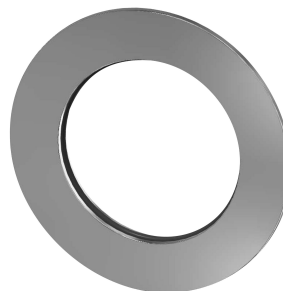

Rosette

2030048765
ASET2006



FRAMIC Self-closing cartridge

2030046145
ASSX9001

KWC

F5S-Therm self-closing thermostatic in-wall mixer

Modell-Linie: F5S | F5ST2036
Showers | Self closing showers

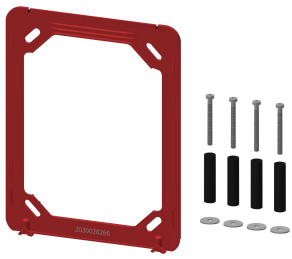

Holding frame

2030045472
ASXX9004

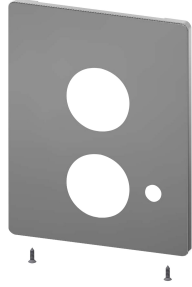

Cover plate stainless steel

2030050138
ASST2004



Stainless steel care set

2000109019
ZWSPL0024



Cleaning product CHROMOL

2000105091
ZWSPL0023