

KWC F5S-Therm self-closing thermostatic in-wall mixer

Modell-Linie: F5S | F5ST2037
Showers | Self closing showers

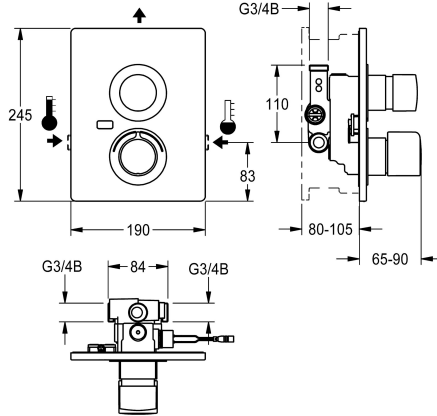

KWC-No.

2030067164

F5S-Therm self-closing thermostatic mixer DN 15 as finished installation kit for wall mounting in mounting kit, for shower facilities. Hydraulically controlled, connects to hot water and cold water. Function block with integrated FRAMIC self-closing cartridge, thermostat and pre-assembled hygiene unit including sensor with control electronics and 6 V lithium battery (CR-P2) to perform automatic water hygiene flushing, program-controlled thermal disinfection (additional bypass solenoid-operated flush valve cartridge necessary) and storage of statistical data. Additional mechanism for second bypass solenoid valve cartridge for separate rinsing of the cold-water line and separate sampling of

cold or hot water. FRAMIC self-closing cartridge, low maintenance and stagnation free, with ceramic disc technology, self closing, flow pressure independent due to medium-independent design. Continuously adjustable flow duration. Thermostat with metal handle with adjustable and turn-proof temperature stop and option for manual thermal disinfection. All-metal construction, visible parts high-polished, chrome-plated. Holding frame including profile seal, stainless steel cover 190 x 245 mm with covered screw fixing, chrome-plated plastic rosettes, non-return valve and strainers. Depth adjustability 25 mm.

Technical Data

additional connections	no
with backflow preventer	yes
Built-in fitting model	no
calculation flow rate cold wat	0.15 l/s
calculation flow rate hot wate	0.15 l/s
circulation	no
compatible A3000 open	no
connection with pay water disp	not possible
Cover plate height	245 mm
Cover plate width	190 mm
default automatic hygiene flus	fixed interval 24 hours
with filter	yes
adjustable flow time	yes
functional principle	hydraulic self-closing
for hand shower	no
hygiene flushing	yes
diameter nominal	DN 15
inlet size	G 3/4 B
Locking mechanism	Top section, ceramic
material casing	stainless steel
material fitting	brass
maximum flow time	35 Seconds

no
yes
no
0.15 l/s
0.15 l/s
no
no
not possible
245 mm
190 mm
fixed interval 24 hours
yes
yes
hydraulic self-closing
no
yes
DN 15
G 3/4 B
Top section, ceramic
stainless steel
brass
35 Seconds

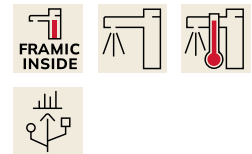

KWC F5S-Therm self-closing thermostatic in-wall mixer

Modell-Linie: **F5S | F5ST2037**
Showers | Self closing showers

minimum flow pressure	1 bar
minimum flow time	5 Seconds
type of mixing	with thermostat
number of batteries	1
Parameterization	remote control
power supply connection	Battery 6 V
power consumption	1.5 Voltampere
Type of power supply	Battery
with rosettes/cover plate	yes
protective shutdown	no
shower pipe draining	no
sound insulation	no
surface finish casing	satin finished
surface finish fitting	chromed
surface treatment fitting	polished
temperature limit	yes
thermal disinfection	yes
with transformer/power supply	no
type of batteries	CR-P2 Lithium battery 6V
type of mounting	in-wall installation with box
type of operation	manual operation
type of sensor	opto-electronic sensor
type of shower	in-wall fitting
volume flow rate at 3 bar	0.2 l/s
water connection	threaded connection (external)
position of water connection	from side
Accent colour	chrome-look (glossy)
Basic colour	stainless steel

Mandatory Accessories



R5 System box for in-wall mixer

2030028990
F5BX2001

Optional Accessories

KWC F5S-Therm self-closing thermostatic in-wall mixer

Modell-Linie: F5S | F5ST2037
Showers | Self closing showers



**Bidirectional remote control for
electronical fittings F3 and F5**

2030036654
ACEX9005



**2-button remote control for fittings F3
and F5**

2030036849
ACEX9004

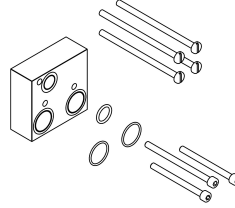

Extension set

2030067889
ACXT9001



Solenoid valve cartridge

2030003033
EAQFU0001

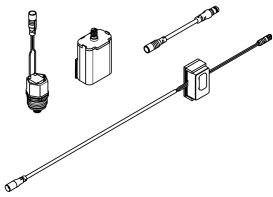

Set for flushing the cold-water line

2030071564
ACXT2005

Spare Parts

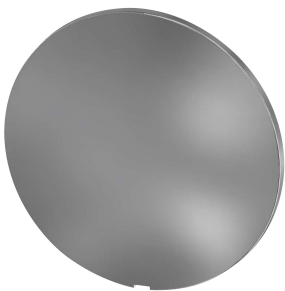

Cover

2030003258
EAQLT0002



Temperature handle

2030047082
ASXT9003

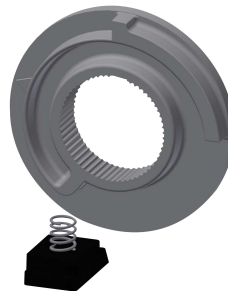

Temperature stop

2030003296
EAQLT0003



Plug chromed

2030053006
ASSX9004

KWC F5S-Therm self-closing thermostatic in-wall mixer

Modell-Linie: F5S | F5ST2037
Showers | Self closing showers



Push cap

2030049943
ASST2001



Safety ring

2030048357
ASSX9003

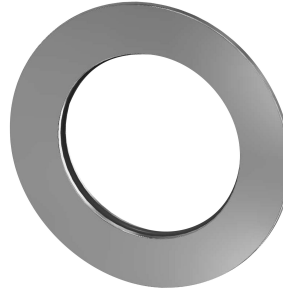

Rosette

2030048765
ASET2006



FRAMIC Self-closing cartridge

2030046145
ASSX9001

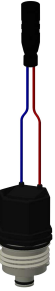

Solenoid valve cartridge

2030003033
EAQFU0001

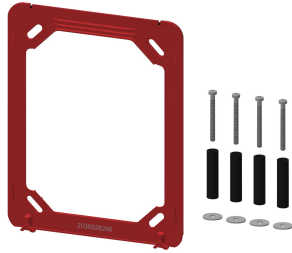

Holding frame

2030045472
ASXX9004

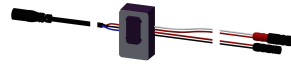

Sensor, ID 81/00001

2030041484
ASLM2001

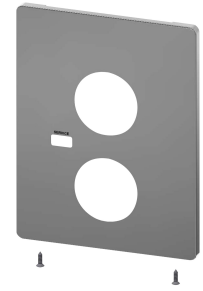

Cover plate stainless steel

2030049948
ASST2002



Lithium battery 6 V

2000104846
EPRTR0008



Stainless steel care set

2000109019
ZWSPLO024



Cleaning product CHROMOL

2000105091
ZWSPLO023