

KWC F5S-Therm Self-closing thermostatic mixer

Modell-Linie: F5S | F5ST2039
Showers | Self closing showers

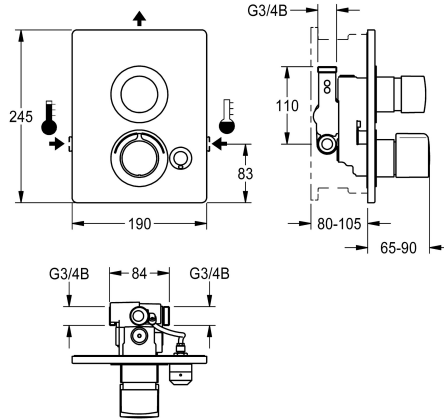

KWC-No.

2030067154

2030067163
With automatic shower pipe emptying

2030067158
Version without option for automatic water hygiene flushing or thermal disinfection

2030067167
with automatic shower pipe draining

shower pipe draining

no

yes

no

yes

thermal disinfection

yes

yes

no

no

F5S-Therm self-closing thermostatic mixer DN 15 as finished installation kit for installation in basic installation kit, for shower facilities. Hydraulically controlled, connects to hot and cold water. Function block with integrated FRAMIC self-closing cartridge and thermostat. FRAMIC self-closing cartridge, hydraulically controlled, low-maintenance and stagnation-free, with ceramic disc technology, self-closing, flow pressure-independent due to medium-separated design. Stepless adjustment of flow duration.

Thermostat with metal handle with adjustable and turn-proof temperature stop and option for manual thermal disinfection. All-metal construction, visible parts high-polished, chromium-plated. Holding frame including profile seal, stainless steel cover plate 190 x 245 mm with covered screw fixing, chromium-plated plastic rosettes, backflow preventer and strainers. Depth adjustability 25 mm. Version with automatic shower pipe draining.

Technical Data

additional connections

no

with backflow preventer

yes

Built-in fitting model

Finishing section

calculation flow rate cold wat

0.15 l/s

calculation flow rate hot wate

0.15 l/s

circulation

no

compatible A3000 open

no

connection with pay water disp

not possible

with filter

yes

adjustable flow time

yes

functional principle

hydraulic self-closing

for hand shower

no

hygiene flushing

no

diameter nominal

DN 15

inlet size

G 3/4 B

Locking mechanism

Top section, ceramic

material casing

stainless steel

material fitting

brass



KWC F5S-Therm Self-closing thermostatic mixer

Modell-Linie: F5S | F5ST2039
Showers | Self closing showers

maximum flow time	35 Seconds
minimum flow pressure	1 bar
minimum flow time	5 Seconds
type of mixing	with thermostat
with rosettes/cover plate	yes
protective shutdown	no
shower pipe draining	yes
sound insulation	no
surface finish casing	satin finished
surface finish fitting	chromed
surface treatment fitting	polished
temperature limit	yes
thermal disinfection	no
type of mounting	in-wall installation with box
type of operation	manual operation
type of shower	in-wall fitting
volume flow rate at 3 bar	0.2 l/s
water connection	threaded connection (external)
position of water connection	from side
Accent colour	chrome-look (glossy)
Basic colour	stainless steel

Mandatory Accessories



R5 System box for in-wall mixer

2030028990
F5BX2001

Optional Accessories

KWC F5S-Therm Self-closing thermostatic mixer

Modell-Linie: F5S | F5ST2039
Showers | Self closing showers

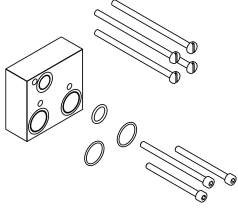

Extension set

2030067889
ACXT9001

Spare Parts



Cover

2030003258
EAQLT0002



Temperature handle

2030047082
ASXT9003

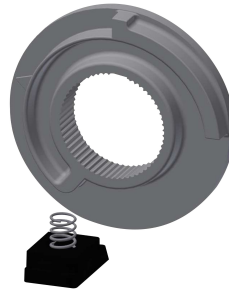

Temperature stop

2030003296
EAQLT0003



Plug chromed

2030053006
ASSX9004



Push cap

2030049943
ASST2001



Guide ring

2030048356
ASSX9002



Safety ring

2030048357
ASSX9003

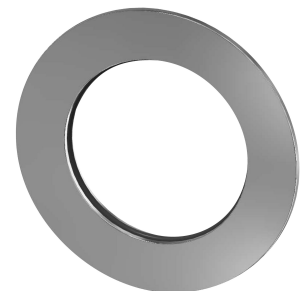

Rosette

2030048765
ASET2006

KWC F5S-Therm Self-closing thermostatic mixer

Modell-Linie: F5S | F5ST2039
Showers | Self closing showers



FRAMIC Self-closing cartridge

2030046145
ASSX9001

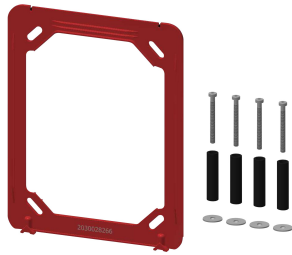

Holding frame

2030045472
ASXX9004

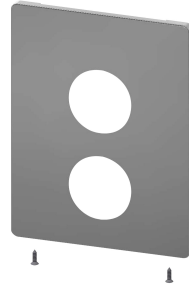

Cover plate stainless steel

2030050136
ASST2003

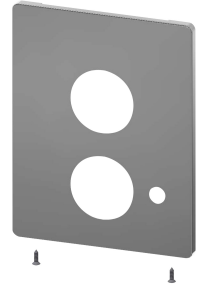

Cover plate stainless steel

2030050138
ASST2004



Stainless steel care set

2000109019
ZWSPL0024



Cleaning product CHROMOL

2000105091
ZWSPL0023