

KWC AQUA 3000 open Elektronikmodul für F5 WC-Spülarmatur

Modell-Linie: AQUA3000OPEN | ACEF4003
Wassermanagement | Zubehör Wassermanagement

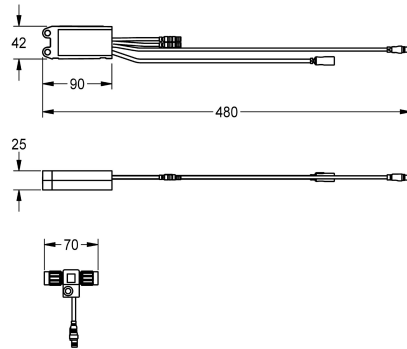

KWC-Nr.

2030067649

Elektronikmodul EM5 mit ID 13020 für F5EF4002

Elektronikmodul EM5 mit ID 13020 und Elektro-T-Verteiler. Zur Einbindung in das Wassermanagementsystem AQUA 3000 open,

24 V DC.

Technische Daten

Füllmenge

1

Mengeneinheit

Stück



Notwendiges Zubehör



ECC2 Funktionscontroller

2000108123
ZA3OP011



ECC2 Funktionscontroller

2030016282
ZA3OP022



Systemkabel

2000100801
ZAQUA077



Systemkabel

2000100852
ZAQUA078

KWC AQUA 3000 open Elektronikmodul für F5 WC-Spülarmatur

Modell-Linie: AQUA3000OPEN | ACEF4003
Wassermanagement | Zubehör Wassermanagement

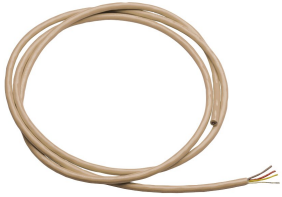

Systemkabel

2000104272
ZAQUA011

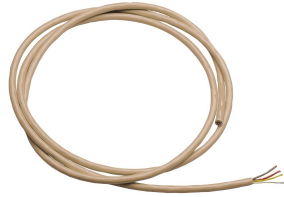

Systemkabel

2000104274
ZAQUA012

Optionales Zubehör

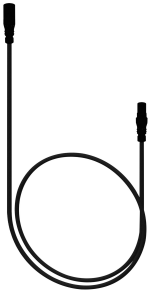

Sensor-Verlängerungskabel

2030041919
ACEX9006

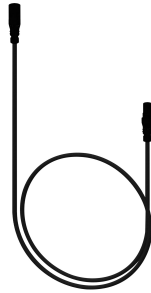

Sensor-Verlängerungskabel

2030041920
ACEX9007

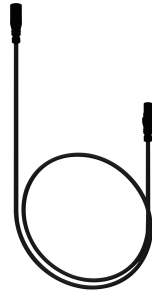

Sensor-Verlängerungskabel

2030056669
ACEX9013



Verlängerungskabel

2000101055
ZAQUA073

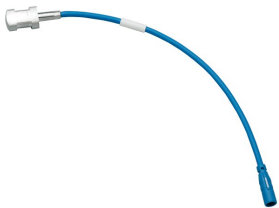

Anlege-Temperaturfühler

2000100976
ZAQUA021