

## KWC F5E-Therm - A3000 open Electronic thermostatic in-wall mixer

**Modell-Linie: F5E | F5ET2040**  
Showers | Electronic self closing shower

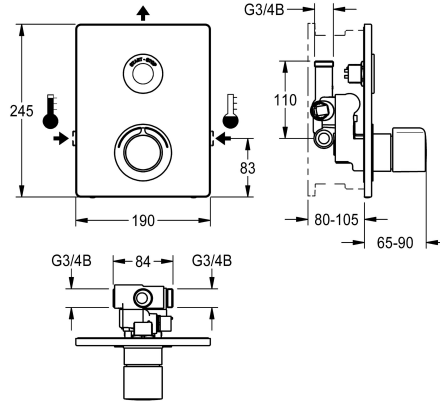

### KWC-No.

**2030071563**

F5E-Therm - A3000 open thermostatic mixer DN 15 as finished installation kit for in-wall installation in basic installation kit, for shower facilities. Electrically controlled, connects to hot water and cold water. Function block with integrated solenoid valve cartridge, thermostat and two bypass solenoid valve cartridges for separate rinsing of the cold-water line and implementation of program-controlled thermal disinfection as well as for separate sampling of cold or hot water. Thermostat with metal handle with adjustable and turn-proof temperature stop and option for manual thermal disinfection. All-metal construction, visible parts high-polished,

chrome-plated. With holding frame with profile seal, 190 x 245 mm stainless steel cover plate with covered screw fixing including touch sensor with control electronics, start/stop function, rosette, watertight electronic module and electric T-junction for connection to system cables, backflow preventers and strainers. Depth adjustability 25 mm. Activated hygiene flushing 24 hours after the last activity. External control unit, like valve setting, cleaning deactivation, storage of statistical data and communication via ECC2 function controller, 24 V DC.

### Technical Data

additional connections	no
with backflow preventer	yes
Built-in fitting model	Finishing section
calculation flow rate cold wat	0.15 l/s
calculation flow rate hot wate	0.15 l/s
circulation	no
compatible A3000 open	yes
connection with pay water disp	single / multiple pay water di
Cover plate height	245 mm
Cover plate width	190 mm
default automatic hygiene flus	24h after the last activity
default flow time	30 Seconds
with filter	yes
adjustable flow time	yes
functional principle	electronic self-closing
for hand shower	no
hygiene flushing	yes
diameter nominal	DN 15
inlet size	G 3/4 B
Locking mechanism	Top section, non-ceramic
material casing	stainless steel
material fitting	brass



## KWC F5E-Therm - A3000 open Electronic thermostatic in-wall mixer

**Modell-Linie: F5E | F5ET2040**

Showers | Electronic self closing shower

maximum flow time	255 Seconds
minimum flow pressure	1 bar
minimum flow time	1 Seconds
type of mixing	with thermostat
Parameterization	network
power supply connection	A3000 open 24 V DC
position of power connection	from top
Type of power supply	Transformer
with rosettes/cover plate	yes
protective shutdown	yes
shower pipe draining	no
sound insulation	no
surface finish casing	satin finished
surface finish fitting	chromed
surface treatment fitting	polished
temperature limit	yes
thermal disinfection	automatic thermal disinfection
with transformer/power supply	no
type of mounting	in-wall installation with box
type of operation	sensor operation
type of sensor	opto-electronic sensor
type of shower	in-wall fitting
Volume flow rate bypass PWH	0.05 l/s
volume flow rate at 3 bar	0.23 l/s
water connection	threaded connection (external)
position of water connection	from side
Accent colour	chrome-look (glossy)
Basic colour	stainless steel

### Mandatory Accessories

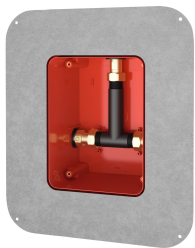

**R5 System box for in-wall mixer**

**2030028990**  
F5BX2001



**ECC2 function controller**

**2000108123**  
ZA3OP0011



**ECC2 function controller**

**2030016282**  
ZA3OP0022



**System cable**

**2000100801**  
ZAQUA077

## KWC F5E-Therm - A3000 open Electronic thermostatic in-wall mixer

Modell-Linie: F5E | F5ET2040  
Showers | Electronic self closing shower

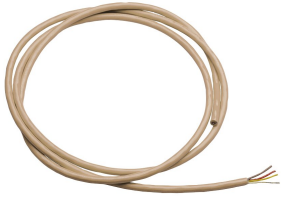

### System cable

**2000100852**  
ZAQUA078

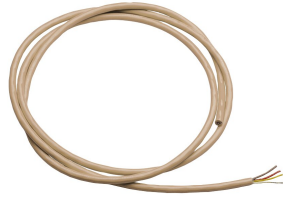

### System cable

**2000104272**  
ZAQUA011

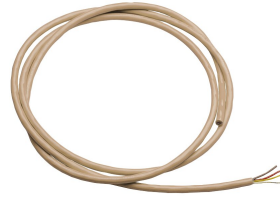

### System cable

**2000104274**  
ZAQUA012

## Optional Accessories

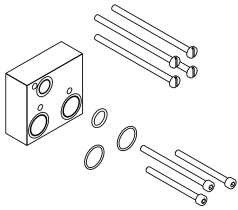

### Extension set

**2030067889**  
ACXT9001

## Spare Parts



### Temperature handle

**2030047082**  
ASXT9003

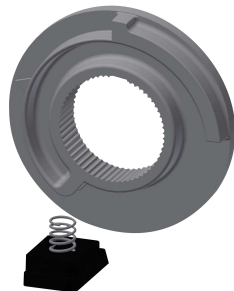

### Temperature stop

**2030003296**  
EAQLT0003



### Electrical T junction

**2000100853**  
ZAQUA075