

KWC F7E Electronic pillar mixer

Modell-Linie: F7 | F7EM1002
Taps | Electronic taps

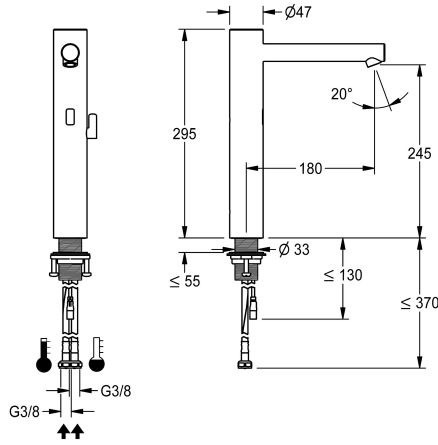

KWC-No.

3600001259

F7E-Mix pillar mixer DN 15 for sanitary facilities, opto-electronically controlled. For connection to hot and cold water via hoses with integrated backflow preventers and strainers. Control electronics, solenoid valve and sensor in stainless steel housing, brushed surface, outlet height 245 mm and projection 180 mm. Stainless steel temperature lever with adjustable, turn-proof temperature stop. Angle-adjustable and anti-theft aerator with integrated flow regulator 5.7 l/min. Activated water hygiene flushing 24 hours after last activation, safety switch-off with continuous reflection and saving of statistical data. With option for parameterization and

communication via optional bidirectional remote control or C module with the necessary app. Optionally for battery operation with battery compartment including 6 V lithium battery (CR-P2) per fitting, for installation below the washbasin, or for separate power supply via power supply unit 6.75 V/12 V DC or AQUA 3000 open system accessories.

Battery compartment including battery or power supply unit with extension cable must be ordered separately.

Technical Data

with backflow preventer
compatible A3000 open
default automatic hygiene flush
depressurised
with filter
functional principle
hygiene flushing
diameter nominal
inlet size
Locking mechanism
material fitting
minimum flow pressure
type of mixing
Parameterization
Pop-up waste set
power supply connection
position of power connection
Type of power supply
with rosettes/cover plate
protective shutdown
sound insulation
Spout

yes
yes
24h after the last activity
no
yes
electronic self-closing
yes
DN 15
G 3/8
Top section, non-ceramic
stainless steel
1 bar
yes
remote control
no
6,75 / 12 V DC / A3000 open
from bottom
Other
no
yes
no
fixed

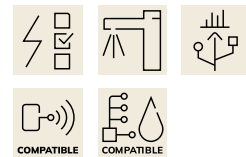

KWC F7E Electronic pillar mixer

Modell-Linie: F7 | F7EM1002
Taps | Electronic taps

surface finish fitting	brushed
surface treatment fitting	brushed
temperature limit	yes
thermal disinfection	no
with transformer/power supply	no
type of mounting	tap hole
type of operation	sensor operation
type of sensor	opto-electronic sensor
type of tap	pillar tap
water connection	hose (gland nut)
Accent colour	none
Basic colour	stainless steel

Mandatory Accessories

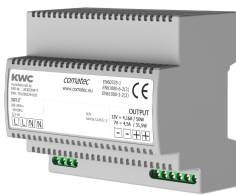

Power supply unit

2030039477
ACEX9001

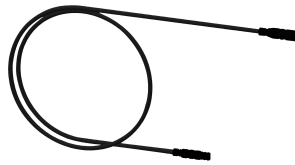

Extension cable 5 m

2030043814
ACEX9010



In-wall power supply

2030039825
ACEX9003

Optional Accessories



Bidirectional remote control for electronic fittings F3 and F5

2030036654
ACEX9005



2-button remote control for fittings F3 and F5

2030036849
ACEX9004



PURETHERM under-table thermostat

2030012758
PURE0031

Spare Parts

KWC F7E Electronic pillar mixer

Modell-Linie: F7 | F7EM1002
Taps | Electronic taps



Stainless steel care set

2000109019
ZWSPL0024



Cleaning product CHROMOL

2000105091
ZWSPL0023
