

## KWC MEDCARE

### Disposable plastic pump for MEDCARE dispenser

Modell-Linie: MEDCARE | CMEDC05P  
Consumables | Consumables Accessories

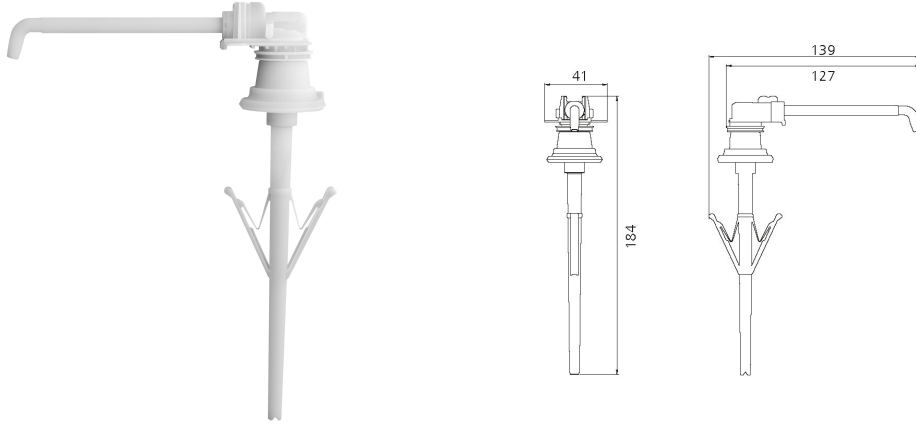

#### KWC-No.

##### 360003360

Disposable plastic pump for MEDCARE dispenser, 500 ml.  
Packaging unit 250 pieces.

##### 360003361

Disposable plastic pump for MEDCARE Spender, 1000 ml.  
Packaging unit 200 pieces.

#### overall height

184 mm

225 mm

#### quantity

250

200

NEW

Disposable plastic pump for MEDCARE dispenser 500 ml, dosage 1.5 ml/stroke, recyclable, individually packed in polybag for

hygiene, packaging unit 250 pieces.

#### Technical Data

overall depth

139 mm

overall height

184 mm

overall width

41 mm

quantity

250

quantity uom

pieces