

KWC MEDCARE

Disposable plastic pump for MEDCARE dispenser

Modell-Linie: MEDCARE | CMEDC05P
Consumables | Consumables Accessories

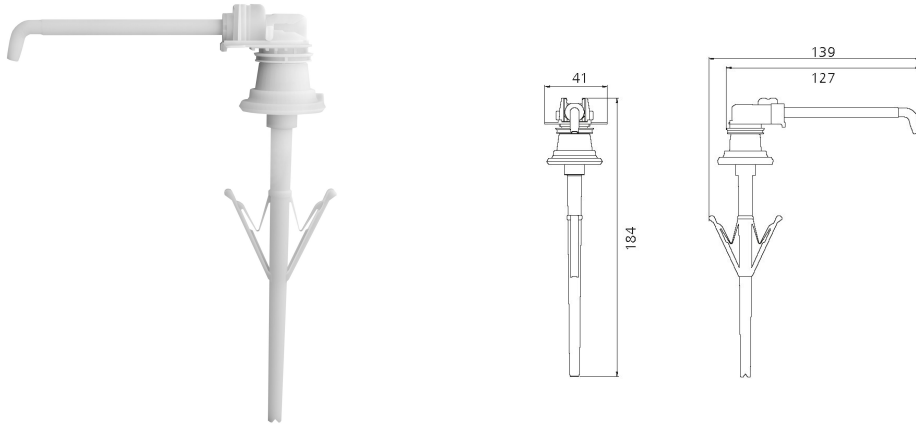

KWC-No.

360003360

Disposable plastic pump for MEDCARE dispenser, 500 ml.
Packaging unit 250 pieces.

360003361

Disposable plastic pump for MEDCARE Spender, 1000 ml.
Packaging unit 200 pieces.

overall height

184 mm

225 mm

quantity

250

200

NEW

Disposable plastic pump for MEDCARE dispenser 500 ml, dosage 1.5 ml/stroke, recyclable, individually packed in polybag for

hygiene, packaging unit 250 pieces.

Technical Data

overall depth

139 mm

overall height

184 mm

overall width

41 mm

quantity

250

quantity uom

pieces