

KWC MEDCARE

Folding support rail with electronic flush actuation

Modell-Linie: MEDCARE | MEDC0011

Grab rails | Grab rail

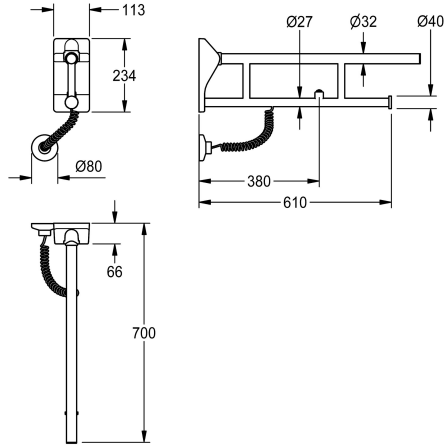

KWC-No.

3600003781

Length 700 mm

3600003782

Length 850 mm

overall depth

700 mm

850 mm

NEW

MEDCARE folding support rail with electronic flush actuation, for wall mounting, stainless steel, basalt grey coated surface, two parallel rail levels, upper rail 32 mm, lower rail 27 mm, material thickness 1.5 mm, with plastic end caps and integrated toilet roll holder, protection against unintentional folding, stainless steel

mounting plate with basalt grey polyamide cover, load capacity up to 150 kg, mounting material to be provided by client.

Dimensions 113 x 234 x 700 mm (W x H x D)

Technical Data

back
material
material code
overall depth
overall height
overall width
surface finish
type of fixing
type of grab rail
type of mounting

no
stainless steel
1.4301 Chrome Nickel steel V2A
700 mm
234 mm
113 mm
satin finished
screw
support bar
wall and floor mounting